

YOUR CHOICE

TIG

INWELT WELDING



YOUR CHOICE

CHANGZHOU INWELT WELDING TECHNOLOGY CO., LTD

Tel: +86 519 81885979

Mob: +86 17315080879

E-mail: cathy.yu@czinwelt.com

**Add: D819, Creativepark, No.9-2, East Taihu Road, Xinbei
District, ChangZhou City**



CONTENT

公司介绍

COMPANY INTRODUCTION

COMPANY INTRODUCTION 公司简介	01
COMPANY PHILOSOPHY 公司理念	02

氩弧焊枪

TIG TORCHES

TIG TORCH 9 TIG9焊枪	03
TIG TORCH 17 TIG17焊枪	07
TIG TORCH 18 TIG18焊枪	11
TIG TORCH 20 TIG20焊枪	14
TIG TORCH 24 TIG24焊枪	17
TIG TORCH 24W TIG24W焊枪	19
TIG TORCH 25 TIG25焊枪	21
TIG TORCH 26 TIG26焊枪	23
TIG TORCH 150 TIG150焊枪	27

配件

SPARE PARTS

CONSUMABLES TIG 9-20-24-25 易损件	29
CONSUMABLES TIG 17-18-26 易损件	31
CONSUMABLES TIG 12 易损件	33
CONSUMABLES TIG 22 易损件	35
CONSUMABLES TIG 27 易损件	37
AIR COOLING CABLES 气冷电缆	39
WATER COOLING CABLESTIG 水冷电缆组	41
CABLESTIG 电缆	42
PLUGS & FITTINGSTIG 接头	43
SWITCH 开关	45
TORCH HANDLES 手柄	46
TORCH HEAD 枪头	47
CABLE COVER 护套	48
ELECTRONIC PLUG 电气插头	49
CABLE & PANEL CONNECTORS 快速插头	51
TUNGSTEN ELECTRODES 钨棒	53

COMPANY INTRODUCTION

公司简介

Inwelt is a customer oriented service platform focusing on welding torches, welding accessories and personal protective equipments. Our goal is to provide comprehensive professional service to our worldwide business partners. Inwelt team working tirelessly to implement industry leading quality control procedures, so our customers can enjoy user friendly ordering service with peace of mind knowing top rated QA team working for them here.

YOUR PROFESSIONAL WELDING SUPPLIER



VISION



To be a world class Supplier of welding products.
A workplace with high employee satisfaction!

成为世界一流的焊接服务商, 做一个高幸福指数的企业!

MISSION



Provide high quality Welding products , highly adaptive operations flow !

为全球客户提供高品质的焊接产品, 更自由的采购模式!

VALUES



Team Work, Embrace Change, Passion for Life!

团队合作, 拥抱变化, 认真生活!

YOUR CHOICE



TIG TORCH 9



EPDM

Technical Data

Cooling: Gas Cooled
Duty 35% DC: 110AMP
Duty 35% AC: 95AMP
Electrode Size: 0.5-1.6mm

技术参数

冷却方式:气冷
直流35% 暂载率:110AMP
交流35% 暂载率:95AMP
电极尺寸:0.5-1.6mm



TIG TORCH 9



M12×1	Code	Description	Pack
Complete torch-EURO	IJPI6317-36	Torch sintig 9F 8m M12X1 焊枪/单开关/TIG9FX/8m/M12X1	1
	IJPI6917-36	Torch sintig 9F 4m M12X1 焊枪/单开关/TIG9FX/4m/M12X1	1
	IJPI7317-36	Torch dubtig 9F 8m M12X1 焊枪/双开关/TIG9FX/8m/M12X1	1
	IJPI7917-36	Torch dubtig 9F 4m M12X1 焊枪/双开关/TIG9FX/4m/M12X1	1
	IJPU6317-36	Torch sintig 9 8m M12X1 焊枪/单开关/TIG9/8m/M12X1	1
	IJPU6917-36	Torch sintig 9 4m M12X1 焊枪/单开关/TIG9/4m/M12X1	1
	IJPU7317-36	Torch dubtig 9 8m M12X1 焊枪/双开关/TIG9/8m/M12X1	1
	IJPU7917-36	Torch dubtig 9 4m M12X1 焊枪/双开关/TIG9/4m/M12X1	1



3/8G	Code	Description	Pack
Complete torch-UK	IJPI6318-36	Torch sintig 9F 8m 3/8G 焊枪/单开关/TIG9FX/8m/3/8G	1
	IJPI6918-36	Torch sintig 9F 4m 3/8G 焊枪/单开关/TIG9FX/4m/3/8G	1
	IJPI7318-36	Torch dubtig 9F 8m 3/8G 焊枪/双开关/TIG9FX/8m/3/8G	1
	IJPI7918-36	Torch dubtig 9F 4m 3/8G 焊枪/双开关/TIG9FX/4m/3/8G	1
	IJPU6318-36	Torch sintig 9 8m 3/8G 焊枪/单开关/TIG9/8m/3/8G	1
	IJPU6918-36	Torch sintig 9 4m 3/8G 焊枪/单开关/TIG9/4m/3/8G	1
	IJPU7318-36	Torch dubtig 9 8m 3/8G 焊枪/双开关/TIG9/8m/3/8G	1
	IJPU7918-36	Torch dubtig 9 4m 3/8G 焊枪/双开关/TIG9/4m/3/8G	1



5/8" 18 UNF R	Code	Description	Pack
Complete torch-USA	IJPI6383-36	Torch sintig 9F 8m 5/8-18UNF 焊枪/单开关/TIG9FX/8m/5/8-18UNF	1
	IJPI6983-36	Torch sintig 9F 4m 5/8-18UNF 焊枪/单开关/TIG9FX/4m/5/8-18UNF	1
	IJPI7383-36	Torch dubtig 9F 8m 5/8-18UNF 焊枪/双开关/TIG9FX/8m/5/8-18UNF	1
	IJPI7983-36	Torch dubtig 9F 4m 5/8-18UNF 焊枪/双开关/TIG9FX/4m/5/8-18UNF	1
	IJPU6383-36	Torch sintig 9 8m 5/8-18UNF 焊枪/单开关/TIG9/8m/5/8-18UNF	1
	IJPU6983-36	Torch sintig 9 4m 5/8-18UNF 焊枪/单开关/TIG9/4m/5/8-18UNF	1
	IJPU7383-36	Torch dubtig 9 8m 5/8-18UNF 焊枪/双开关/TIG9/8m/5/8-18UNF	1
	IJPU7983-36	Torch dubtig 9 4m 5/8-18UNF 焊枪/双开关/TIG9/4m/5/8-18UNF	1



TIG TORCH 9



Leather

Technical Data

Cooling: Gas Cooled
 Duty 35% DC: 110AMP
 Duty 35% AC: 95AMP
 Electrode Size: 0.5-1.6mm

技术参数

冷却方式:气冷
 直流35% 暂载率:110AMP
 交流35% 暂载率:95AMP
 电极尺寸:0.5-1.6mm



M12×1	Code	Description	Pack
Complete torch-EURO	IJPI7117-36	Torch four switches 9F 4m M12X1/leather 焊枪/四开关/TIG9FX/4m/M12X1/皮护套	1
	IJPI7417-36	Torch dubtig 9F 8m M12X1/leather 焊枪/双开关/TIG9FX/8m/M12X1/皮护套	1
	IJPI7517-36	Torch dubtig 9F 4m M12X1/leather 焊枪/双开关/TIG9FX/4m/M12X1/皮护套	1
	IJPI8017-36	Torch four switches 9F 8m M12X1/leather 焊枪/四开关/TIG9FX/8m/M12X1/皮护套	1
	IJPU7117-36	Torch four switches 9 4m M12X1/leather 焊枪/四开关/TIG9/4m/M12X1/皮护套	1
	IJPU7417-36	Torch dubtig 9 8m M12X1/leather 焊枪/双开关/TIG9/8m/M12X1/皮护套	1
	IJPU7517-36	Torch dubtig 9 4m M12X1/leather 焊枪/双开关/TIG9/4m/M12X1/皮护套	1
	IJPU8017-36	Torch four switches 9 8m M12X1/leather 焊枪/四开关/TIG9/8m/M12X1/皮护套	1



TIG TORCH 9



EPDM

Technical Data

Cooling: Gas Cooled
 Duty 35% DC: 110AMP
 Duty 35% AC: 95AMP
 Electrode Size: 0.5-1.6mm

技术参数

冷却方式:气冷
 直流35% 暂载率:110AMP
 交流35% 暂载率:95AMP
 电极尺寸:0.5-1.6mm



M12x1	Code	Description	Pack
	IJPT9317-00	Torch Tig9V 8m M12X1 焊枪/TIG9V/8m/M12X1	1
	IJPT9917-00	Torch Tig9V 4m M12X1 焊枪/TIG9V/4m/M12X1	1
	IJPV9317-00	Torch auto Tig9 8m M12X1 自动焊枪/TIG9/8m/M12X1	1
	IJPV9917-00	Torch auto Tig9 4m M12X1 自动焊枪/TIG9/4m/M12X1	1

3/8G	Code	Description	Pack
	IJPT9318-00	Torch Tig9V 8m 3/8G 焊枪/TIG9V/8m/3/8G	1
	IJPT9918-00	Torch Tig9V 4m 3/8G 焊枪/TIG9V/4m/3/8G	1
	IJPV9318-00	Torch auto Tig9 8m 3/8G 自动焊枪/TIG9/8m/3/8G	1
	IJPV9918-00	Torch auto Tig9 4m 3/8G 自动焊枪/TIG9/4m/3/8G	1

TIG TORCH 17



Technical Data

Cooling: Gas Cooled
Duty 35% DC: 140AMP
Duty 35% AC: 125AMP
Electrode Size: 0.5-2.4mm

技术参数

冷却方式:气冷
直流35% 暂载率:140AMP
交流35% 暂载率:125AMP
电极尺寸:0.5-2.4mm



TIG TORCH 17



M12×1	Code	Description	Pack
Complete torch-EURO	JPJ6317-36	Torch sintig 17F 8m M12X1 焊枪/单开关/TIG17FX/8m/M12X1	1
	JPJ6917-36	Torch sintig 17F 4m M12X1 焊枪/单开关/TIG17FX/4m/M12X1	1
	JPJ7317-36	Torch dubtig 17F 8m M12X1 焊枪/双开关/TIG17FX/8m/M12X1	1
	JPJ7917-36	Torch dubtig 17F 4m M12X1 焊枪/双开关/TIG17FX/4m/M12X1	1
	JPA6317-36	Torch sintig 17 8m M12X1 焊枪/单开关/TIG17/8m/M12X1	1
	JPA6917-36	Torch sintig 17 4m M12X1 焊枪/单开关/TIG17/4m/M12X1	1
	JPA7317-36	Torch dubtig 17 8m M12X1 焊枪/双开关/TIG17/8m/M12X1	1
	JPA7917-36	Torch dubtig 17 4m M12X1 焊枪/双开关/TIG17/4m/M12X1	1



3/8G	Code	Description	Pack
Complete torch-UK	IJPI6318-36	Torch sintig 17F 8m 3/8G 焊枪/单开关/TIG17FX/8m/3/8G	1
	IJPI6918-36	Torch sintig 17F 4m 3/8G 焊枪/单开关/TIG17FX/4m/3/8G	1
	IJPI7318-36	Torch dubtig 17F 8m 3/8G 焊枪/双开关/TIG17FX/8m/3/8G	1
	IJPI7918-36	Torch dubtig 17F 4m 3/8G 焊枪/双开关/TIG17FX/4m/3/8G	1
	IJPU6318-36	Torch sintig 17 8m 3/8G 焊枪/单开关/TIG17/8m/3/8G	1
	IJPU6918-36	Torch sintig 17 4m 3/8G 焊枪/单开关/TIG17/4m/3/8G	1
	IJPU7318-36	Torch dubtig 17 8m 3/8G 焊枪/双开关/TIG17/8m/3/8G	1
	IJPU7918-36	Torch dubtig 17 4m 3/8G 焊枪/双开关/TIG17/4m/3/8G	1



5/8" 18 UNF R	Code	Description	Pack
Complete torch-USA	IJPJ6383-36	Torch sintig 17F 8m 5/8-18UNF 焊枪/单开关/TIG17FX/8m/5/8-18UNF	1
	IJPJ6983-36	Torch sintig 17F 4m 5/8-18UNF 焊枪/单开关/TIG17FX/4m/5/8-18UNF	1
	IJPJ7383-36	Torch dubtig 17F 8m 5/8-18UNF 焊枪/双开关/TIG17FX/8m/5/8-18UNF	1
	IJPJ7983-36	Torch dubtig 17F 4m 5/8-18UNF 焊枪/双开关/TIG17FX/4m/5/8-18UNF	1
	IJPA6383-36	Torch sintig 17 8m 5/8-18UNF 焊枪/单开关/TIG17/8m/5/8-18UNF	1
	IJPA6983-36	Torch sintig 17 4m 5/8-18UNF 焊枪/单开关/TIG17/4m/5/8-18UNF	1
	IJPA7383-36	Torch dubtig 17 8m 5/8-18UNF 焊枪/双开关/TIG17/8m/5/8-18UNF	1
	IJPA7983-36	Torch dubtig 17 4m 5/8-18UNF 焊枪/双开关/TIG17/4m/5/8-18UNF	1



TIG TORCH 17



Leather

Technical Data

Cooling: Gas Cooled
 Duty 35% DC: 140AMP
 Duty 35% AC: 125AMP
 Electrode Size: 0.5-2.4mm

技术参数

冷却方式:气冷
 直流35% 暂载率:140AMP
 交流35% 暂载率:125AMP
 电极尺寸:0.5-2.4mm



M12×1	Code	Description	Pack
	IJPJ7117-36	Torch four switches 17F 4m M12X1/leather 焊枪/四开关/TIG17FX/4m/M12X1/皮护套	1
	IJPJ7417-36	Torch dubtig 17F 8m M12X1/leather 焊枪/双开关/TIG17FX/8m/M12X1/皮护套	1
	IJPJ7517-36	Torch dubtig 17F 4m M12X1/leather 焊枪/双开关/TIG17FX/4m/M12X1/皮护套	1
	IJPJ8017-36	Torch four switches 17F 8m M12X1/leather 焊枪/四开关/TIG17FX/8m/M12X1/皮护套	1
	IJPA7117-36	Torch four switches 17 4m M12X1/leather 焊枪/四开关/TIG17/4m/M12X1/皮护套	1
	IJPA7417-36	Torch dubtig 17 8m M12X1/leather 焊枪/双开关/TIG17/8m/M12X1/皮护套	1
	IJPA7517-36	Torch dubtig 17 4m M12X1/leather 焊枪/双开关/TIG17/4m/M12X1/皮护套	1
	IJPA8017-36	Torch four switches 17 8m M12X1/leather 焊枪/四开关/TIG17/8m/M12X1/皮护套	1

TIG TORCH 17



EPDM

Technical Data

Cooling: Gas Cooled
 Duty 35% DC: 140AMP
 Duty 35% AC: 125AMP
 Electrode Size: 0.5-2.4mm

技术参数

冷却方式:气冷
 直流35% 暂载率:140AMP
 交流35% 暂载率:125AMP
 电极尺寸:0.5-2.4mm



M12x1	Code	Description	Pack
	IJPO9317-00	Torch TIG17V 8m M12X1 焊枪/TIG17V/8m/M12X1	1
	IJPO9917-00	Torch TIG17V 4m M12X1 焊枪/TIG17V/4m/M12X1	1
	IJPG9317-00	Torch auto TIG17 8m M12X1 自动焊枪/TIG17/8m/M12X1	1
	IJPG9917-00	Torch auto TIG17 4m M12X1 自动焊枪/TIG17/4m/M12X1	1

3/8G	Code	Description	Pack
	IJPO9318-00	Torch TIG17V 8m 3/8G 焊枪/TIG17V/8m/3/8G	1
	IJPO9918-00	Torch TIG17 4m 3/8G 焊枪/TIG17V/4m/3/8G	1
	IJPG9318-00	Torch auto TIG17 8m 3/8G 自动焊枪/TIG17/8m/3/8G	1
	IJPG9918-00	Torch auto TIG17 4m 3/8G 自动焊枪/TIG17/4m/3/8G	1

TIG TORCH 18



EPDM

Technical Data

Cooling: Water Cooled
 Duty 100% DC: 320AMP
 Duty 100% AC: 240AMP
 Electrode Size: 0.5-4mm

技术参数

冷却方式:水冷
 直流100% 暂载率:320AMP
 交流100% 暂载率:240AMP
 电极尺寸:0.5-4mm



M12X1 1/4G 3/8G	Code	Description	Pack
	IJPC6317-36	Torch sintig 18 8m M12X1 焊枪/单开关/TIG18/8m/M12X1	1
	IJPC6917-36	Torch sintig 18 4m M12X1 焊枪/单开关/TIG18/4m/M12X1	1
	IJPC7317-36	Torch dubtig 18 8m M12X1 焊枪/双开关/TIG18/8m/M12X1	1
	IJPC7917-36	Torch dubtig 18 4m M12X1 焊枪/双开关/TIG18/4m/M12X1	1

3/8G	Code	Description	Pack
	IJPC6318-36	Torch sintig 18 8m 3/8G 焊枪/单开关/TIG18/8m/3/8G	1
	IJPC6918-36	Torch sintig 18 4m 3/8G 焊枪/单开关/TIG18/4m/3/8G	1
	IJPC7318-36	Torch dubtig 18 8m 3/8G 焊枪/双开关/TIG18/8m/3/8G	1
	IJPC7918-36	Torch dubtig 18 4m 3/8G 焊枪/双开关/TIG18/4m/3/8G	1

TIG TORCH 18



Leather



Technical Data

Cooling: Water Cooled
 Duty 100% DC: 320AMP
 Duty 100% AC: 240AMP
 Electrode Size: 0.5-4mm

技术参数

冷却方式:水冷
 直流100% 暂载率:320AMP
 交流100% 暂载率:240AMP
 电极尺寸:0.5-4mm



M12X1 1/4G 3/8G	Code	Description	Pack
Complete torch-EURO	IJPC7117-36	Torch four switches 18 4m M12X1/leather 焊枪/四开关/TIG18/4m/M12X1/皮护套	1
	IJPC7417-36	Torch dubtig 18 8m M12X1/leather 焊枪/双开关/TIG18/8m/M12X1/皮护套	1
	IJPC7517-36	Torch dubtig 18 4m M12X1/leather 焊枪/双开关/TIG18/4m/M12X1/皮护套	1
	IJPC8017-36	Torch four switches 18 8m M12X1/leather 焊枪/四开关/TIG18/8m/M12X1/皮护套	1

TIG TORCH 18







Technical Data

Cooling: Water Cooled
 Duty 100% DC: 320AMP
 Duty 100% AC: 240AMP
 Electrode Size: 0.5-4mm

技术参数

冷却方式:水冷
 直流100% 暂载率:320AMP
 交流100% 暂载率:240AMP
 电极尺寸:0.5-4mm



M12X1 1/4G 3/8G	Code	Description	Pack
	IJPZ9317-00	Torch four switches 18 4m M12X1/leather 焊枪/四开关/TIG18/4m/M12X1/皮护套	1
	IJPZ9917-00	Torch dubtig 18 8m M12X1/leather 焊枪/双开关/TIG18/8m/M12X1/皮护套	1
	IJPH9317-00	Torch dubtig 18 4m M12X1/leather 焊枪/双开关/TIG18/4m/M12X1/皮护套	1
	IJPH9917-00	Torch four switches 18 8m M12X1/leather 焊枪/四开关/TIG18/8m/M12X1/皮护套	1

TIG TORCH 20



EPDM

Technical Data

Cooling: Water Cooled
 Duty 100% DC: 250AMP
 Duty 100% AC: 220AMP
 Electrode Size: 0.5-3.2mm

技术参数

冷却方式:水冷
 直流100% 暂载率:250AMP
 交流100% 暂载率:220AMP
 电极尺寸:0.5-3.2mm

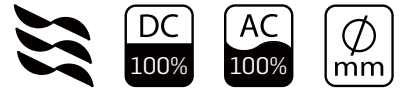

M12X1 1/4G 3/8G	Code	Description	Pack
	IJPN6317-36	Torch sintig 20 8m M12X1 焊枪/单开关/TIG20/8m/M12X1	1
	IJPN6917-36	Torch sintig 20 4m M12X1 焊枪/单开关/TIG20/4m/M12X1	1
	IJPN7317-36	Torch dubtig 20 8m M12X1 焊枪/双开关/TIG20/8m/M12X1	1
	IJPN7917-36	Torch dubtig 20 4m M12X1 焊枪/双开关/TIG20/4m/M12X1	1

3/8G	Code	Description	Pack
	IJPN6318-36	Torch sintig 20 8m 3/8G 焊枪/单开关/TIG20/8m/3/8G	1
	IJPN6918-36	Torch sintig 20 4m 3/8G 焊枪/单开关/TIG20/4m/3/8G	1
			1
			1

TIG TORCH 20



Leather

Technical Data

Cooling: Water Cooled
 Duty 100% DC: 250AMP
 Duty 100% AC: 220AMP
 Electrode Size: 0.5-3.2mm

技术参数

冷却方式:水冷
 直流100% 暂载率:250AMP
 交流100% 暂载率:220AMP
 电极尺寸:0.5-3.2mm



M12X1 1/4G 3/8G	Code	Description	Pack
	IJPN7117-36	Torch four switches 20 4m M12X1/leather 焊枪/四开关/TIG20/4m/M12X1/皮护套	1
	IJPN7417-36	Torch dubtig 20 8m M12X1/leather 焊枪/双开关/TIG20/8m/M12X1/皮护套	1
	IJPN7517-36	Torch dubtig 20 4m M12X1/leather 焊枪/双开关/TIG20/4m/M12X1/皮护套	1
	IJPN8017-36	Torch four switches 20 8m M12X1/leather 焊枪/四开关/TIG20/8m/M12X1/皮护套	1

TIG TORCH 20



EPDM

Technical Data

Cooling: Water Cooled
 Duty 100% DC: 250AMP
 Duty 100% AC: 220AMP
 Electrode Size: 0.5-3.2mm

技术参数

冷却方式:水冷
 直流100% 暂载率:250AMP
 交流100% 暂载率:220AMP
 电极尺寸:0.5-3.2mm



M12X1 1/4G 3/8G	Code	Description	Pack
	IJPN9317-00	Torch TIG 20V 8m 焊枪/TIG20V/8m	1
	IJPN9917-00	Torch TIG 20V 4m 焊枪/TIG20V/4m	1
	IJPR9317-00	Auto torch TIG 20 8m 自动焊枪/TIG20/8m	1
	IJPR9917-00	Auto torch TIG 20 4m 自动焊枪/TIG20/4m	1

TIG TORCH 24



Technical Data

Cooling: Gas Cooled
 Duty 35% DC: 110AMP
 Duty 35% AC: 95AMP
 Electrode Size: 0.5-2.4mm

技术参数

冷却方式:气冷
 直流35% 暂载率:110AMP
 交流35% 暂载率:95AMP
 电极尺寸:0.5-2.4mm



M12x1	Code	Description	Pack
Complete torch-EURO	IJPL6317-36	Torch sintig 24F 8m M12X1 焊枪/单开关/TIG24FX/8m/M12X1	1
	IJPL6917-36	Torch sintig 24F 4m M12X1 焊枪/单开关/TIG24FX/4m/M12X1	1
	IJPL7317-36	Torch dubtig 24F 8m M12X1 焊枪/双开关/TIG24FX/8m/M12X1	1
	IJPL7917-36	Torch dubtig 24F 4m M12X1 焊枪/双开关/TIG24FX/4m/M12X1	1
	IJPW6317-36	Torch sintig 24 8m M12X1 焊枪/单开关/TIG24/8m/M12X1	1
	IJPW6917-36	Torch sintig 24 4m M12X1 焊枪/单开关/TIG24/4m/M12X1	1
	IJPW7317-36	Torch dubtig 24 8m M12X1 焊枪/双开关/TIG24/8m/M12X1	1
	IJPW7917-36	Torch dubtig 24 4m M12X1 焊枪/双开关/TIG24/4m/M12X1	1



3/8G	Code	Description	Pack
Complete torch-UK	IJPL6318-36	Torch sintig 24F 8m 3/8G 焊枪/单开关/TIG24FX/8m/3/8G	1
	IJPL6918-36	Torch sintig 24F 4m 3/8G 焊枪/单开关/TIG24FX/4m/3/8G	1
	IJPL7318-36	Torch dubtig 24F 8m 3/8G 焊枪/双开关/TIG24FX/8m/3/8G	1
	IJPL7918-36	Torch dubtig 24F 4m 3/8G 焊枪/双开关/TIG24FX/4m/3/8G	1
	IJPW6318-36	Torch sintig 24 8m 3/8G 焊枪/单开关/TIG24/8m/3/8G	1
	IJPW6918-36	Torch sintig 24 4m 3/8G 焊枪/单开关/TIG24/4m/3/8G	1
	IJPW7318-36	Torch dubtig 24 8m 3/8G 焊枪/双开关/TIG24/8m/3/8G	1
	IJPW7918-36	Torch dubtig 24 4m 3/8G 焊枪/双开关/TIG24/4m/3/8G	1



TIG TORCH 24



Leather

Technical Data

Cooling: Gas Cooled
 Duty 35% DC: 110AMP
 Duty 35% AC: 95AMP
 Electrode Size: 0.5-2.4mm

技术参数

冷却方式:气冷
 直流35% 暂载率:110AMP
 交流35% 暂载率:95AMP
 电极尺寸:0.5-2.4mm



M12×1	Code	Description	Pack
Complete torch-EURO	JPL7117-36	Torch four switches 24F 4m M12×1/leather 焊枪/四开关/TIG24FX/4m/M12×1/皮护套	1
	JPL7417-36	Torch dubtig 24F 8m M12×1/leather 焊枪/双开关/TIG24FX/8m/M12×1/皮护套	1
	JPL7517-36	Torch dubtig 24F 4m M12×1/leather 焊枪/双开关/TIG24FX/4m/M12×1/皮护套	1
	JPL8017-36	Torch four switches 24F 8m M12×1/leather 焊枪/四开关/TIG24FX/8m/M12×1/皮护套	1
	JPW7117-36	Torch four switches 24 4m M12×1/leather 焊枪/四开关/TIG24/4m/M12×1/皮护套	1
	JPW7417-36	Torch dubtig 24 8m M12×1/leather 焊枪/双开关/TIG24/8m/M12×1/皮护套	1
	JPW7517-36	Torch dubtig 24 4m M12×1/leather 焊枪/双开关/TIG24/4m/M12×1/皮护套	1
	JPW8017-36	Torch four switches 24 8m M12×1/leather 焊枪/四开关/TIG24/8m/M12×1/皮护套	1



TIG TORCH 24W



Technical Data

Cooling: Water Cooled
 Duty 100% DC: 180AMP
 Duty 100% AC: 120AMP
 Electrode Size: 0.5-2.4mm

技术参数

冷却方式:水冷
 直流100% 暂载率:180AMP
 交流100% 暂载率:120AMP
 电极尺寸:0.5-2.4mm



1/4G M12x1 3/8G	Code	Description	Pack
	IJPB6317-36	Torch sintig 24WF 8m M12X1 焊枪/单开关/TIG24W FX/8m/M12X1	1
	IJPB6917-36	Torch sintig 24WF 4m M12X1 焊枪/单开关/TIG24W FX/4m/M12X1	1
	IJPB7317-36	Torch dubtig 24WF 8m M12X1 焊枪/双开关/TIG24W FX/8m/M12X1	1
	IJPB7917-36	Torch dubtig 24WF 4m M12X1 焊枪/双开关/TIG24W FX/4m/M12X1	1
	IJPY6317-36	Torch sintig 24W 8m M12X1 焊枪/单开关/TIG24W/8m/M12X1	1
	IJPY6917-36	Torch sintig 24W 4m M12X1 焊枪/单开关/TIG24W/4m/M12X1	1
	IJPY7317-36	Torch dubtig 24W 8m M12X1 焊枪/双开关/TIG24W/8m/M12X1	1
	IJPY7917-36	Torch dubtig 24W 4m M12X1 焊枪/双开关/TIG24W/4m/M12X1	1

3/8G	Code	Description	Pack
	IJPB6318-36	Torch sintig 24WF 8m 3/8G 焊枪/单开关/TIG24W FX/8m/3/8G	1
	IJPB6918-36	Torch sintig 24WF 4m 3/8G 焊枪/单开关/TIG24W FX/4m/3/8G	1
	IJPB7318-36	Torch dubtig 24WF 8m 3/8G 焊枪/双开关/TIG24W FX/8m/3/8G	1
	IJPB7918-36	Torch dubtig 24WF 4m 3/8G 焊枪/双开关/TIG24W FX/4m/3/8G	1
	IJPY6318-36	Torch sintig 24W 8m 3/8G 焊枪/单开关/TIG24W/8m/3/8G	1
	IJPY6918-36	Torch sintig 24W 4m 3/8G 焊枪/单开关/TIG24W/4m/3/8G	1
	IJPY7318-36	Torch dubtig 24W 8m 3/8G 焊枪/双开关/TIG24W/8m/3/8G	1
	IJPY7918-36	Torch dubtig 24W 4m 3/8G 焊枪/双开关/TIG24W/4m/3/8G	1

TIG TORCH 24W



Leather





Technical Data

Cooling: Water Cooled
 Duty 100% DC: 180AMP
 Duty 100% AC: 120AMP
 Electrode Size: 0.5-2.4mm

技术参数

冷却方式:水冷
 直流100% 暂载率:180AMP
 交流100% 暂载率:120AMP
 电极尺寸:0.5-2.4mm



1/4G M12x1 3/8G	Code	Description	Pack
	IJPB7117-36	Torch four switches 24W 4m M12x1/leather 焊枪/四开关/TIG24W/4m/M12x1/皮护套	1
	IJPB7417-36	Torch dubtig 24W 8m M12x1/leather 焊枪/双开关/TIG24W/8m/M12x1/皮护套	1
	IJPB7517-36	Torch dubtig 24W 4m M12x1/leather 焊枪/双开关/TIG24W/4m/M12x1/皮护套	1
	IJPB8017-36	Torch four switches 24W 8m M12x1/leather 焊枪/四开关/TIG24W/8m/M12x1/皮护套	1

TIG TORCH 25



EPDM



Leather

Technical Data

Cooling: Water Cooled
Duty 100% DC: 250AMP
Duty 100% AC: 220AMP
Electrode Size: 0.5-3.2mm

技术参数

冷却方式:水冷
直流100% 暂载率:250AMP
交流100% 暂载率:220AMP
电极尺寸:0.5-3.2mm



TIG TORCH 25



1/4G M12x1 3/8G	Code	Description	Pack
Complete torch-EURO	IJK6317-36	Torch sintig 25 8m M12X1 焊枪/单开关/TIG25/8m/M12X1	1
	IJK6917-36	Torch sintig 25 4m M12X1 焊枪/单开关/TIG25/4m/M12X1	1
	IJK7317-36	Torch dubtig 25 8m M12X1 焊枪/双开关/TIG25/8m/M12X1	1
	IJK7917-36	Torch dubtig 25 4m M12X1 焊枪/双开关/TIG25/4m/M12X1	1



3/8G	Code	Description	Pack
Complete torch-UK	IJK6318-36	Torch dubtig 25 8m M12X1 焊枪/双开关/TIG25/8m/M12X1	1
	IJK6918-36	Torch dubtig 25 4m M12X1 焊枪/双开关/TIG25/4m/M12X1 11	1
	IJK7318-36	Torch dubtig 25 8m 3/8G 焊枪/双开关/TIG25/8m/3/8G	1
	IJK7918-36	Torch dubtig 25 4m 3/8G 焊枪/双开关/TIG25/4m/3/8G	1



5/8" 18 UNF R	Code	Description	Pack
Complete torch-USA	IJK7117-36	Torch four switches 25 4m M12X1/leather 焊枪/四开关/TIG25/4m/M12X1/皮护套	1
	IJK7417-36	Torch dubtig 25 8m M12X1/leather 焊枪/双开关/TIG25/8m/M12X1/皮护套	1
	IJK7517-36	Torch dubtig 25 4m M12X1/leather 焊枪/双开关/TIG25/4m/M12X1/皮护套	1
	IJK8017-36	Torch four switches 25 8m M12X1/leather 焊枪/四开关/TIG25/8m/M12X1/皮护套	1



TIG TORCH 26



EPDM

Technical Data

Cooling: Gas Cooled
Duty 35% DC: 180AMP
Duty 35% AC: 150AMP
Electrode Size: 0.5-4mm

技术参数

冷却方式:气冷
直流35% 暂载率:180AMP
交流35% 暂载率:150AMP
电极尺寸:0.5-4mm



TIG TORCH 26



M12×1	Code	Description	Pack
Complete torch-EURO	IJPS6317-36	Torch sintig 26F 8m M12X1 焊枪/单开关/TIG26FX/8m/M12X1	1
	IJPS6917-36	Torch sintig 26F 4m M12X1 焊枪/单开关/TIG26FX/4m/M12X1	1
	IJPS7317-36	Torch dubtig 26F 8m M12X1 焊枪/双开关/TIG26FX/8m/M12X1	1
	IJPS7917-36	Torch dubtig 26F 4m M12X1 焊枪/双开关/TIG26FX/4m/M12X1	1
	IJPX6317-36	Torch sintig 26 8m M12X1 焊枪/单开关/TIG26/8m/M12X1	1
	IJPX6917-36	Torch sintig 26 4m M12X1 焊枪/单开关/TIG26/4m/M12X1	1
	IJPX7317-36	Torch dubtig 26 8m M12X1 焊枪/双开关/TIG26/8m/M12X1	1
	IJPX7917-36c	Torch dubtig 26 4m M12X1 焊枪/双开关/TIG26/4m/M12X1	1



3/8G	Code	Description	Pack
Complete torch-UK	IJPS6318-36	Torch sintig 26F 8m 3/8G 焊枪/单开关/TIG26FX/8m/3/8G	1
	IJPS6918-36	Torch sintig 26F 4m 3/8G 焊枪/单开关/TIG26FX/4m/3/8G	1
	IJPS7318-36	Torch dubtig 26F 8m 3/8G 焊枪/双开关/TIG26FX/8m/3/8G	1
	IJPS7918-36	Torch dubtig 26F 4m 3/8G 焊枪/双开关/TIG26FX/4m/3/8G	1
	IJPX6318-36	Torch sintig 26 8m 3/8G 焊枪/单开关/TIG26/8m/3/8G	1
	IJPX6918-36	Torch sintig 26 4m 3/8G 焊枪/单开关/TIG26/4m/3/8G	1
	IJPX7318-36	Torch dubtig 26 8m 3/8G 焊枪/双开关/TIG26/8m/3/8G	1
	IJPX7918-36	Torch dubtig 26 4m 3/8G 焊枪/双开关/TIG26/4m/3/8G	1



5/8" 18 UNF R	Code	Description	Pack
Complete torch-USA	IJPS6383-36	Torch sintig 26F 8m 5/8-18UNF 焊枪/单开关/TIG26FX/8m/5/8-18UNF	1
	IJPS6983-36	Torch sintig 26F 4m 5/8-18UNF 焊枪/单开关/TIG26FX/4m/5/8-18UNF	1
	IJPS7383-36	Torch dubtig 26F 8m 5/8-18UNF 焊枪/双开关/TIG26FX/8m/5/8-18UNF	1
	IJPS7983-36	Torch dubtig 26F 4m 5/8-18UNF 焊枪/双开关/TIG26FX/4m/5/8-18UNF	1
	IJPX6383-36	Torch sintig 26 8m 5/8-18UNF 焊枪/单开关/TIG26/8m/5/8-18UNF	1
	IJPX6983-36	Torch sintig 26 4m 5/8-18UNF 焊枪/单开关/TIG26/4m/5/8-18UNF	1
	IJPX7383-36	Torch dubtig 26 8m 5/8-18UNF 焊枪/双开关/TIG26/8m/5/8-18UNF	1
	IJPX7983-36	Torch dubtig 26 4m 5/8-18UNF 焊枪/双开关/TIG26/4m/5/8-18UNF	1





Leather

Technical Data

Cooling: Gas Cooled
 Duty 35% DC: 180AMP
 Duty 35% AC: 150AMP
 Electrode Size: 0.5-4mm

技术参数

冷却方式:气冷
 直流35% 暂载率:180AMP
 交流35% 暂载率:150AMP
 电极尺寸:0.5-4mm



M12x1	Code	Description	Pack
	IJPS7117-36	Torch four switches 26F 4m M12X1/leather 焊枪/四开关/TIG26FX/4m/M12X1/皮护套	1
	IJPS7417-36	Torch dubtig 26F 8m M12X1/leather 焊枪/双开关/TIG26FX/8m/M12X1/皮护套	1
	IJPS7517-36	Torch dubtig 26F 4m M12X1/leather 焊枪/双开关/TIG26FX/4m/M12X1/皮护套	1
	IJPS8017-36	Torch four switches 26F 8m M12X1/leather 焊枪/四开关/TIG26FX/8m/M12X1/皮护套	1
	IJPX7117-36	Torch four switches 26 4m M12X1/leather 焊枪/四开关/TIG26/4m/M12X1/皮护套	1
	IJPX7417-36	Torch dubtig 26 8m M12X1/leather 焊枪/双开关/TIG26/8m/M12X1/皮护套	1
	IJPX7517-36	Torch dubtig 26 4m M12X1/leather 焊枪/双开关/TIG26/4m/M12X1/皮护套	1
	IJPX8017-36	Torch four switches 26 8m M12X1/leather 焊枪/四开关/TIG26/8m/M12X1/皮护套	1

TIG TORCH 26



EPDM

Technical Data

Cooling: Gas Cooled
 Duty 35% DC: 180AMP
 Duty 35% AC: 150AMP
 Electrode Size: 0.5-4mm

技术参数

冷却方式:气冷
 直流35% 暂载率:180AMP
 交流35% 暂载率:150AMP
 电极尺寸:0.5-4mm



M12x1	Code	Description	Pack
	IJPD9317-00	Torch TIG26V 8m M12X1 焊枪/TIG26V/8m/M12X1	1
	IJPD9917-00	Torch TIG26V 4m M12X1 焊枪/TIG26V/4m/M12X1	1
	IJPE9317-00	Torch auto TIG26 8m M12X1 自动焊枪/TIG26/8m/M12X1	1
	IJPE9917-00	Torch auto TIG26 4m M12X1 自动焊枪/TIG26/4m/M12X1	1

3/8G	Code	Description	Pack
	IJPD9318-00	Torch TIG26V 8m 3/8G 焊枪/TIG26V/8m/3/8G	1
	IJPD9918-00	Torch TIG26 4m 3/8G 焊枪/TIG26V/4m/3/8G	1
	IJPE9318-00	Torch auto TIG26 8m 3/8G 自动焊枪/TIG26/8m/3/8G	1
	IJPE9918-00	Torch auto TIG26 4m 3/8G 自动焊枪/TIG26/4m/3/8G	1

TIG TORCH 150



EPDM

Technical Data

Cooling: Gas Cooled
 Duty 35% DC: 80AMP
 Duty 35% AC: 65AMP
 Electrode Size: 1.6-2.0mm

技术参数

冷却方式:气冷
 直流35% 暂载率:80AMP
 交流35% 暂载率:65AMP
 电极尺寸:1.6-2.0mm



M16X1.5	Code	Description	Pack
 Complete torch-EURO	IJPF6316	TORCH TIG150/8M M16x1.5 焊枪/TIG150/8M M16x1.5	1
	IJPF6376	TORCH TIG150/8M/6mmq M16x1.5 焊枪/TIG150/8M/6mmq M16x1.5	1
	IJPF6386	TORCH TIG150/8M/8mmq M16x1.5 焊枪/TIG150/8M/8mmq M16x1.5	1
	IJPF6916	TORCH TIG150/4M M16x1.5 焊枪/TIG150/4M M16x1.5	1
	IJPF6976	TORCH TIG150/4M/6mmq M16x1.5 焊枪/TIG150/4M/6mmq M16x1.5	1
	IJPF6986	TORCH TIG150/4M/8mmq M16x1.5 焊枪/TIG150/4M/8mmq M16x1.5	1



Code	Description	Pack
IJHA0014	Torch Head TIG150 枪头 TIG150	10
IJK0063	Short Back Cap TIG150 短柄帽 TIG150	10
IJK0060	Long Back Cap TIG150 长柄帽 TIG150	10
IJHV0012-16	Collet ϕ 1.6 TIG150 电极夹 ϕ 1.6 TIG150	10
IJHV0012-20	Collet ϕ 2.0 TIG150 电极夹 ϕ 2.0 TIG150	10
IJHG0075	Collet Body TIG150 电极夹座 TIG150	10
IJHT0062	Alumina Cup GR6 TIG150 陶瓷喷嘴GR4 TIG150	10
IJHT0063	Alumina Cup GR6 TIG150 陶瓷喷嘴GR5 TIG150	10
IJHT0064	Alumina Cup GR6 TIG150 陶瓷喷嘴GR6 TIG150	10

CONSUMABLES TIG 9-20-24-25 易损件

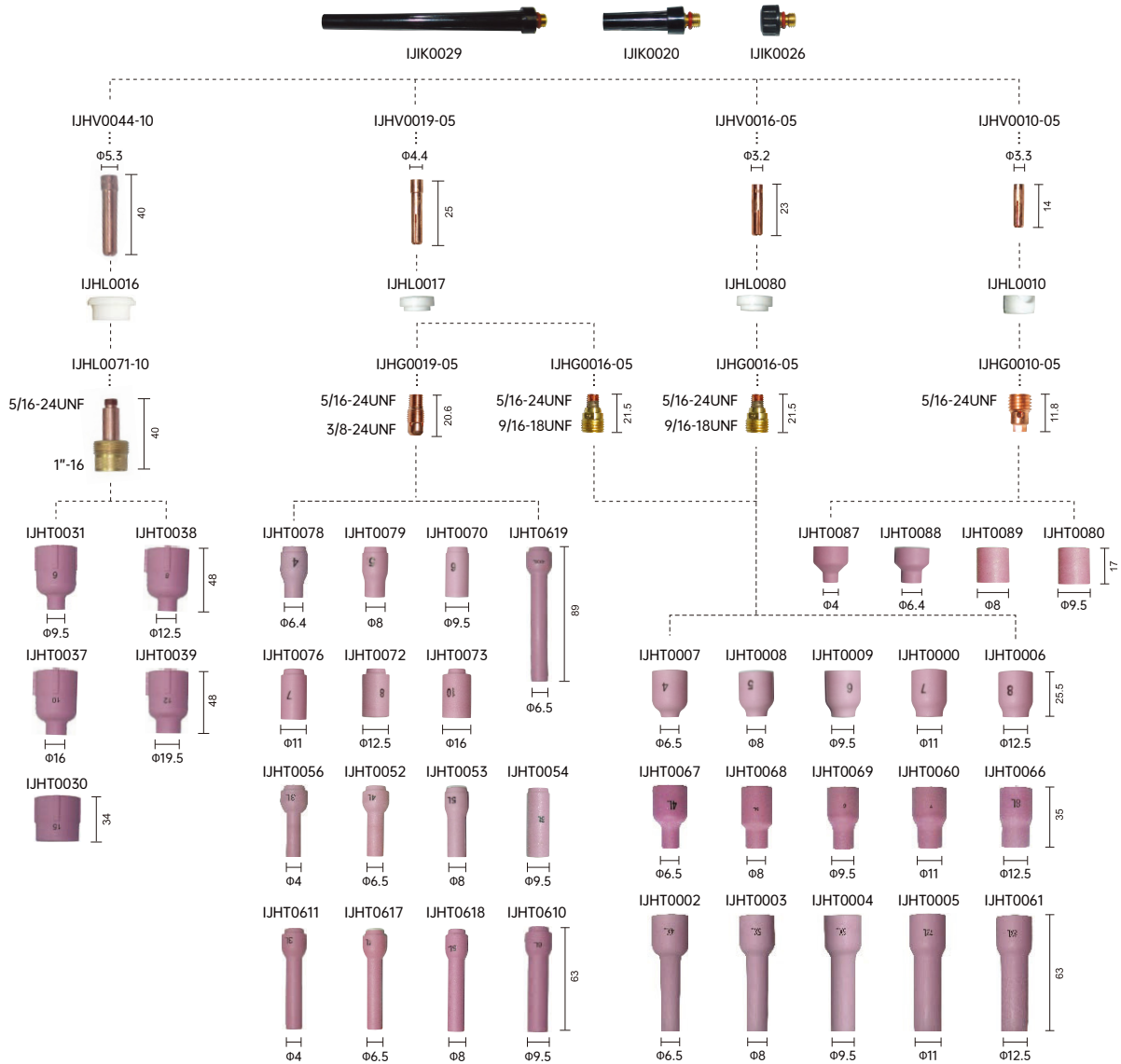

Code	Ref.	Description	Pack
IJHG0016-05	45V41	Collet body gas lens ϕ 0.5mm TIG24-24W 气塞连接体 ϕ 0.5mm/TIG24-24W	10
IJHG0016-10	45V42	Collet body gas lens ϕ 1.0mm TIG24-24W 气塞连接体 ϕ 1.0mm/TIG24-24W	10
IJHG0016-16	45V43	Collet body gas lens ϕ 1.6mm TIG24-24W 气塞连接体 ϕ 1.6mm/TIG24-24W	10
IJHG0016-20	70058	Collet body gas lens ϕ 2.0mm TIG24-24W 气塞连接体 ϕ 2.0mm/TIG24-24W	10
IJHG0016-24	45V44	Collet body gas lens ϕ 2.4mm TIG24-24W 气塞连接体 ϕ 2.4mm/TIG24-24W	10
IJHG0016-32	45V45	Collet body gas lens ϕ 3.2mm TIG24-24W 气塞连接体 ϕ 3.2mm/TIG24-24W	10
IJHG0019-05	13N25	Collet body ϕ 0.5mm TIG9-20-25 电极夹座 ϕ 0.5mm/TIG9-20-25	10

Code	Ref.	Description	Pack
IJHG0019-12	701.0276	Collet body ϕ 1.2mm TIG9-20-25 电极夹座 ϕ 1.2mm/TIG9-20-25	10
IJHG0019-16	13N27	Collet body ϕ 1.6mm TIG9-20-25 电极夹座 ϕ 1.6mm/TIG9-20-25	10
IJHG0019-20	70067WT	Collet body ϕ 2.0mm TIG9-20-25 电极夹座 ϕ 2.0mm/TIG9-20-25	10
IJHG0019-24	13N28	Collet body ϕ 2.4mm TIG9-20-25 电极夹座 ϕ 2.4mm/TIG9-20-25	10
IJHG0019-32	13N29	Collet body ϕ 3.2mm TIG9-20-25 电极夹座 ϕ 3.2mm/TIG9-20-25	10
IJHG0010-05	53N17	Collet body ϕ 0.5mm TIG24-24W 电极夹座 ϕ 0.5mm TIG24-24W	10
IJHG0010-10	53N18	Collet body ϕ 1.0mm TIG24-24W 电极夹座 ϕ 1.0mm TIG24-24W	10

CONSUMABLES TIG 9-20-24-25 易损件



Code	Ref.	Description	Pack	Code	Ref.	Description	Pack
IJHG0019-10	13N26	Collet body ϕ 1.0mm TIG9-20-25 电极夹座 ϕ 1.0mm/TIG9-20-25	10	IJHG0010-16	53N19	Collet body ϕ 1.6mm TIG24-24W 电极夹座 ϕ 1.6mm TIG24-24W	10
IJHG0010-24	24CB352	Collet body ϕ 2.4mm TIG24-24W 电极夹座 ϕ 2.4mm/TIG24-24W	10	IJHT0005	53N61XL	Alumina cup gas lens GR7 TIG24-24W 陶瓷喷嘴 GR7/TIG24-24W	10
IJHG0071-10	45V0204S	Extra large gas lens ϕ 1.0mm TIG9-20-25 加大气塞连接体 ϕ 1.0mm/TIG9-20-25	10	IJHT0006	53N61S	Alumina cup gas lens GR8 TIG24-24W 陶瓷喷嘴 GR8/TIG24-24W	10
IJHG0071-16	45V116S	Extra large gas lens ϕ 1.6mm TIG9-20-25 加大气塞连接体 ϕ 1.6mm/TIG9-20-25	10	IJHT0007	53N58	Alumina cup gas lens GR4 TIG24-24W 陶瓷喷嘴 GR4/TIG24-24W	10
IJHG0071-24	45V64S	Extra large gas lens ϕ 2.4mm TIG9-20-25 加大气塞连接体 ϕ 2.4mm/TIG9-20-25	10	IJHT0008	53N59	Alumina cup gas lens GR5 TIG24-24W 陶瓷喷嘴 GR5/TIG24-24W	10
IJHG0071-32	995795S	Extra large gas lens ϕ 3.2mm TIG9-20-25 加大气塞连接体 ϕ 3.2mm/TIG9-20-25	10	IJHT0009	53N60	Alumina cup gas lens GR6 TIG24-24W 陶瓷喷嘴 GR6/TIG24-24W	10
IJHG0071-40	45V63S	Extra large gas lens ϕ 4.0mm TIG9-20-25 加大气塞连接体 ϕ 4.0mm/TIG9-20-25	10	IJHT0000	53N61	Alumina cup gas lens GR7 TIG24-24W 陶瓷喷嘴 GR7/TIG24-24W	10
IJHL0017	598882	Insulator torch body TIG9-20-25 枪头绝缘帽/TIG9-20-25	10	IJHT0611	796F74	Alumina cup GR3XL TIG9-20-25 陶瓷喷嘴 GR3XL/TIG9-20-25	10
IJHL0010	53N22	Insulator torch body TIG24-24W 枪头绝缘帽/TIG24-24W	10	IJHT0617	796F75	Alumina cup GR4XL TIG9-20-25 陶瓷喷嘴 GR4XL/TIG9-20-25	10
IJHL0077	54N63-20	Large gas lens insulator torch body TIG9-20 加大枪头绝缘帽/TIG9-20	10	IJHT0618	796F76	Alumina cup GR5XL TIG9-20-25 陶瓷喷嘴 GR5XL/TIG9-20-25	10
IJHL0080	53N66	Large gas lens insulator torch body TIG24-24W 加大枪头绝缘帽/TIG24-24W	10	IJHT0619	796F79	Alumina cup GR4XXL TIG9-20-25 陶瓷喷嘴 GR4XXL/TIG9-20-25	10
IJHT0031	57N75	Alumina cup gas lens XL GR6 加大陶瓷喷嘴 GR6	10	IJHT0610	796F77	Alumina cup GR6XL TIG9-20-25 陶瓷喷嘴 GR6XL/TIG9-20-25	10
IJHT0037	57N74	Alumina cup gas lens XL GR8 加大陶瓷喷嘴 GR8	10	IJHV0016-05	53N62	Collet ϕ 0.5mm gas lens TIG24-24W 电极夹 ϕ 0.5mm/TIG24-24W	10
IJHT0038	53N88	Alumina cup gas lens XL GR10 加大陶瓷喷嘴 GR10	10	IJHV0016-10	53N63	Collet ϕ 1.0mm gas lens TIG24-24W 电极夹 ϕ 1.0mm/TIG24-24W	10
IJHT0039	53N87	Alumina cup gas lens XL GR12 加大陶瓷喷嘴 GR12	10	IJHV0016-16	53N64	Collet ϕ 1.6mm gas lens TIG24-24W 电极夹 ϕ 1.6mm/TIG24-24W	10
IJHT0030	53N89	Alumina cup gas lens XL GR15 加大陶瓷喷嘴 GR15	10	IJHV0016-24	24GLC332	Collet ϕ 2.4mm gas lens TIG24-24W 电极夹 ϕ 2.4mm/TIG24-24W	10
IJHT0052	796F71	Alumina cup GR4L TIG9-20-25 陶瓷喷嘴 GR4L/TIG9-20-25	10	IJHV0019-05	13N20	Collet ϕ 0.5mm TIG9-20-25 电极夹 ϕ 0.5mm/TIG9-20-25	10
IJHT0053	796F72	Alumina cup GR5L TIG9-20-25 陶瓷喷嘴 GR5L/TIG9-20-25	10	IJHV0019-10	13N21	Collet ϕ 1.0mm TIG9-20-25 电极夹 ϕ 1.0mm/TIG9-20-25	10
IJHT0054	796F73	Alumina cup GR6L TIG9-20-25 陶瓷喷嘴 GR6L/TIG9-20-25	10	IJHV0019-12	701.0254	Collet ϕ 1.2mm TIG9-20-25 电极夹 ϕ 1.2mm/TIG9-20-25	10
IJHT0056	796F70	Alumina cup GR3L TIG9-20-25 陶瓷喷嘴 GR3L/TIG9-20-25	10	IJHV0019-16	13N22	Collet ϕ 1.6mm TIG9-20-25 电极夹 ϕ 1.6mm/TIG9-20-25	10
IJHT0061	53N61SXL	Alumina cup gas lens GR8 TIG24-24W 陶瓷喷嘴 GR8/TIG24-24W	10	IJHV0019-20	70066WT	Collet ϕ 2.0mm TIG9-20-25 电极夹 ϕ 2.0mm/TIG9-20-25	10
IJHT0066	53N61SL	Alumina cup gas lens GR8 TIG24-24W 陶瓷喷嘴 GR8/TIG24-24W	10	IJHV0019-24	13N23	Collet ϕ 2.4mm TIG9-20-25 电极夹 ϕ 2.4mm/TIG9-20-25	10
IJHT0067	53N58L	Alumina cup gas lens GR4 TIG24-24W 陶瓷喷嘴 GR4/TIG24-24W	10	IJHV0019-32	13N24	Collet ϕ 3.2mm TIG9-20-25 电极夹 ϕ 3.2mm/TIG9-20-25	10
IJHT0068	53N59L	Alumina cup gas lens GR5 TIG24-24W 陶瓷喷嘴 GR5/TIG24-24W	10	IJHV0010-05	53N15	Collet ϕ 0.5mm TIG24-24W 电极夹 ϕ 0.5mm/TIG24-24W	10
IJHT0069	53N60L	Alumina cup gas lens GR6 TIG24-24W 陶瓷喷嘴 GR6/TIG24-24W	10	IJHV0010-10	53N16	Collet ϕ 1.0mm TIG24-24W 电极夹 ϕ 1.0mm/TIG24-24W	10
IJHT0060	53N61L	Alumina cup gas lens GR7 TIG24-24W 陶瓷喷嘴 GR7/TIG24-24W	10	IJHV0010-16	53N14	Collet ϕ 1.6mm TIG24-24W 电极夹 ϕ 1.6mm/TIG24-24W	10
IJHT0072	13N12	Alumina cup GR8 TIG9-20-25 陶瓷喷嘴 GR8/TIG9-20-25	10	IJHV0010-24	24GLC332	Collet ϕ 2.4mm TIG24-24W 电极夹 ϕ 2.4mm/TIG24-24W	10
IJHT0073	13N13	Alumina cup GR10 TIG9-20-25 陶瓷喷嘴 GR10/TIG9-20-25	10	IJHV0044-05	13N20L	Collet ϕ 0.5mm TIG9-20 电极夹 ϕ 0.5mm/TIG9-20	10
IJHT0076	13N11	Alumina cup GR7 TIG9-20-25 陶瓷喷嘴 GR7/TIG9-20-25	10	IJHV0044-10	13N21L	Collet ϕ 1.0mm TIG9-20 电极夹 ϕ 1.0mm/TIG9-20	10
IJHT0078	13N08	Alumina cup GR4 TIG9-20-25 陶瓷喷嘴 GR4/TIG9-20-25	10	IJHV0044-16	13N22L	Collet ϕ 1.6mm TIG9-20 电极夹 ϕ 1.6mm/TIG9-20	10
IJHT0079	13N09	Alumina cup GR5 TIG9-20-25 陶瓷喷嘴 GR5/TIG9-20-25	10	IJHV0044-20	13N23ML	Collet ϕ 2.0mm TIG9-20 电极夹 ϕ 2.0mm/TIG9-20	10
IJHT0070	13N10	Alumina cup GR6 TIG9-20-25 陶瓷喷嘴 GR6/TIG9-20-25	10	IJHV0044-24	13N23L	Collet ϕ 2.4mm TIG9-20 电极夹 ϕ 2.4mm/TIG9-20	10
IJHT0087	53N23	Alumina cup GR3 TIG24-24W 陶瓷喷嘴 GR3/TIG24-24W	10	IJHV0044-32	13N24L	Collet ϕ 3.2mm TIG9-20 电极夹 ϕ 3.2mm/TIG9-20	10
IJHT0088	53N24	Alumina cup GR4 TIG24-24W 陶瓷喷嘴 GR4/TIG24-24W	10	IJK0026	41V33	Short back cap TIG9-20-25 短柄帽/TIG9-20-25	10
IJHT0089	53N25	Alumina cup GR5 TIG24-24W 陶瓷喷嘴 GR5/TIG24-24W	10	IJK0029	41V24	Long back cap TIG9-20-25 长柄帽/TIG9-20-25	10
IJHT0080	53N27	Alumina cup GR6 TIG24-24W 陶瓷喷嘴 GR6/TIG24-24W	10	IJK0020	41V35	Medium back cap TIG9-20-25 中柄帽/TIG9-20-25	10
IJHT0002	53N58XL	Alumina cup gas lens GR4 TIG24-24W 陶瓷喷嘴 GR4/TIG24-24W	10				
IJHT0003	53N59XL	Alumina cup gas lens GR5 TIG24-24W 陶瓷喷嘴 GR5/TIG24-24W	10				
IJHT0004	53N60XL	Alumina cup gas lens GR6 TIG24-24W 陶瓷喷嘴 GR6/TIG24-24W	10				

CONSUMABLES TIG 17-18-26 易损件



IJIK0022



IJIK0062



IJIK0023

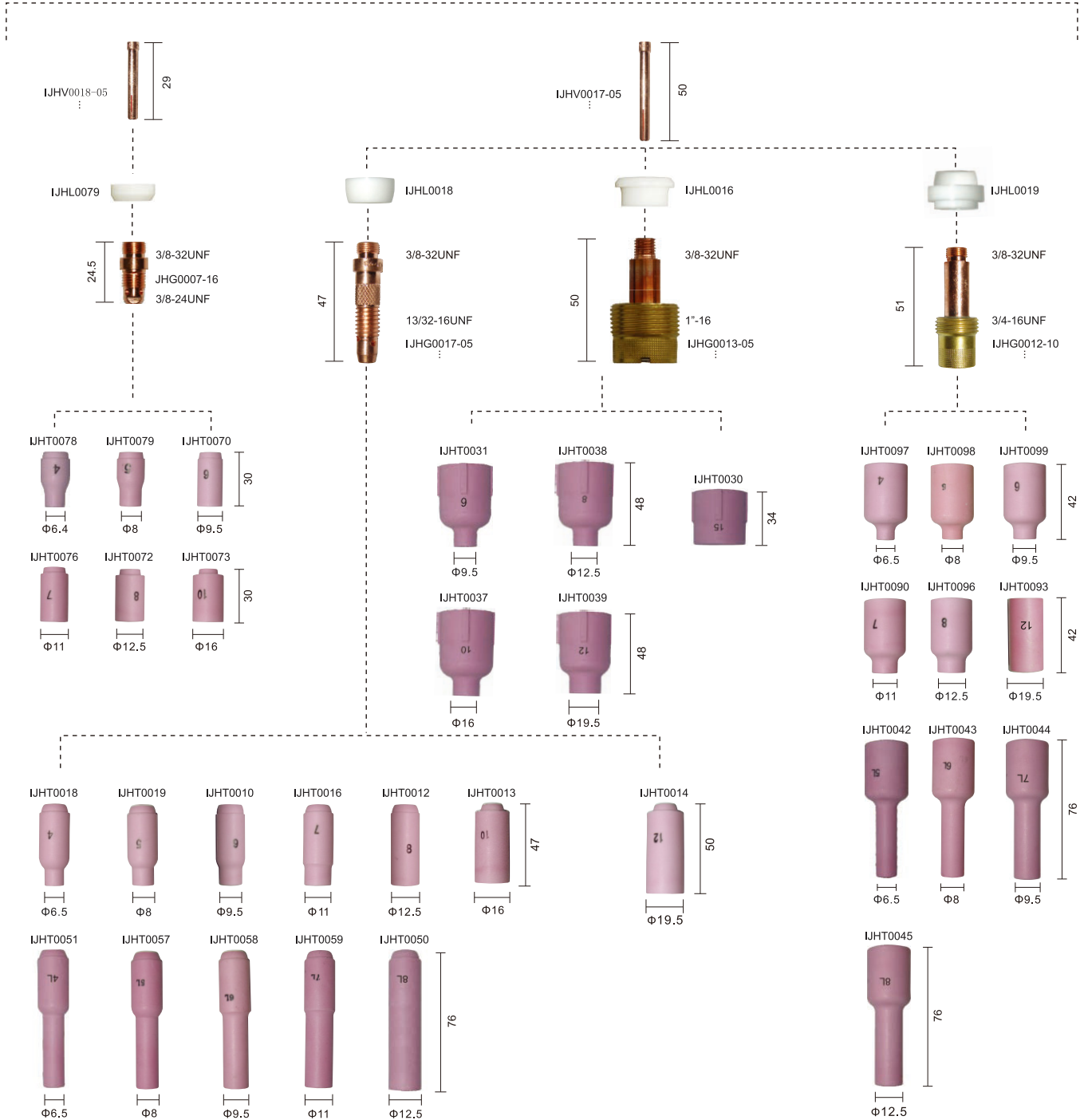

CONSUMABLES TIG 17-18-26 易损件



Code	Ref.	Description	Pack	Code	Ref.	Description	Pack
IJHG0012-05	45V29	Collet body gas lens ϕ 0.5mm TIG17-18-26 气塞连接体 ϕ 0.5mm/TIG17-18-26	10	IJHT0042	54N17L	Alumina cup gas lens GR5L/TIG17-18-26 陶瓷喷嘴 GR5L/TIG17-18-26	10
IJHG0012-10	45V24	Collet body gas lens ϕ 1.0mm TIG17-18-26 气塞连接体 ϕ 1.0mm/TIG17-18-26	10	IJHT0043	54N16L	Alumina cup gas lens GR6L/TIG17-18-26 陶瓷喷嘴 GR6L/TIG17-18-26	10
IJHG0012-16	45V25	Collet body gas lens ϕ 1.6mm TIG17-18-26 气塞连接体 ϕ 1.6mm/TIG17-18-26	10	IJHT0044	54N15L	Alumina cup gas lens GR7L/TIG17-18-26 陶瓷喷嘴 GR7L/TIG17-18-26	10
IJHG0012-20	70060WT	Collet body gas lens ϕ 2.0mm TIG17-18-26 气塞连接体 ϕ 2.0mm/TIG17-18-26	10	IJHT0045	54N14L	Alumina cup gas lens GR8L/TIG17-18-26 陶瓷喷嘴 GR8L/TIG17-18-26	10
IJHG0012-24	45V26	Collet body gas lens ϕ 2.4mm TIG17-18-26 气塞连接体 ϕ 2.4mm/TIG17-18-26	10	IJHT0051	10N50L	Alumina cup GR4L/TIG17-18-26 陶瓷喷嘴 GR4L/TIG17-18-26	10
IJHG0012-32	45V27	Collet body gas lens ϕ 3.2mm TIG17-18-26 气塞连接体 ϕ 3.2mm/TIG17-18-26	10	IJHT0057	10N49L	Alumina cup GR5L/TIG17-18-26 陶瓷喷嘴 GR5L/TIG17-18-26	10
IJHG0012-40	45V28	Collet body gas lens ϕ 4.0mm TIG17-18-26 气塞连接体 ϕ 4.0mm/TIG17-18-26	10	IJHT0058	10N48L	Alumina cup GR6L/TIG17-18-26 陶瓷喷嘴 GR6L/TIG17-18-26	10
IJHG0013-10	45V0204	Collet body large gas lens ϕ 1.0mm TIG17-18-26 加大气塞连接体 ϕ 1.0mm/TIG17-18-26	10	IJHT0059	10N47L	Alumina cup GR7L/TIG17-18-26 陶瓷喷嘴 GR7L/TIG17-18-26	10
IJHG0013-16	45V116	Collet body large gas lens ϕ 1.6mm TIG17-18-26 加大气塞连接体 ϕ 1.6mm/TIG17-18-26	10	IJHT0050	10N46L	Alumina cup GR8L/TIG17-18-26 陶瓷喷嘴 GR8L/TIG17-18-26	10
IJHG0013-24	45V64	Collet body large gas lens ϕ 2.4mm TIG17-18-26 加大气塞连接体 ϕ 2.4mm/TIG17-18-26	10	IJHT0072	13N12	Alumina cup GR8 TIG9-20-25 陶瓷喷嘴 GR8/TIG9-20-25	10
IJHG0013-32	995795	Collet body large gas lens ϕ 3.2mm TIG17-18-26 加大气塞连接体 ϕ 3.2mm/TIG17-18-26	10	IJHT0073	13N13	Alumina cup GR10 TIG9-20-25 陶瓷喷嘴 GR10/TIG9-20-25	10
IJHG0013-40	45V63	Collet body large gas lens ϕ 4.0mm TIG17-18-26 加大气塞连接体 ϕ 4.0mm/TIG17-18-26	10	IJHT0076	13N11	Alumina cup GR7 TIG9-20-25 陶瓷喷嘴 GR7/TIG9-20-25	10
IJHG0017-05	10N29	Collet body ϕ 0.5mm TIG17-18-26 电极夹座 ϕ 0.5mm/TIG17-18-26	10	IJHT0078	13N08	Alumina cup GR4 TIG9-20-25 陶瓷喷嘴 GR4/TIG9-20-25	10
IJHG0017-10	10N30	Collet body ϕ 1.0mm TIG17-18-26 电极夹座 ϕ 1.0mm/TIG17-18-26	10	IJHT0079	13N09	Alumina cup GR5 TIG9-20-25 陶瓷喷嘴 GR5/TIG9-20-25	10
IJHG0017-16	10N31	Collet body ϕ 1.6mm TIG17-18-26 电极夹座 ϕ 1.6mm/TIG17-18-26	10	IJHT0070	13N10	Alumina cup GR6 TIG9-20-25 陶瓷喷嘴 GR6/TIG9-20-25	10
IJHG0017-20	70064WT	Collet body ϕ 2.0mm TIG17-18-26 电极夹座 ϕ 2.0mm/TIG17-18-26	10	IJHT0093	54N19	Alumina cup gas lens GR11 TIG17-18-26 陶瓷喷嘴 GR11/TIG17-18-26	10
IJHG0017-24	10N32	Collet body ϕ 2.4mm TIG17-18-26 电极夹座 ϕ 2.4mm/TIG17-18-26	10	IJHT0096	54N14	Alumina cup gas lens GR8 TIG17-18-26 陶瓷喷嘴 GR8/TIG17-18-26	10
IJHG0017-32	10N28	Collet body ϕ 3.2mm TIG17-18-26 电极夹座 ϕ 3.2mm/TIG17-18-26	10	IJHT0097	54N18	Alumina cup gas lens GR4 TIG17-18-26 陶瓷喷嘴 GR4/TIG17-18-26	10
IJHG0017-40	406488	Collet body ϕ 4.0mm TIG17-18-26 电极夹座 ϕ 4.0mm/TIG17-18-26	10	IJHT0098	54N17	Alumina cup gas lens GR5 TIG17-18-26 陶瓷喷嘴 GR5/TIG17-18-26	10
IJHG0017-48	30126	Collet body ϕ 4.8mm TIG17-18-26 电极夹座 ϕ 4.8mm/TIG17-18-26	10	IJHT0099	54N16	Alumina cup gas lens GR6 TIG17-18-26 陶瓷喷嘴 GR6/TIG17-18-26	10
IJHG0018-16	17CB20	Collet body ϕ 24.5mm TIG17-18-26 电极夹座 ϕ 24.5mm/TIG17-18-26	10	IJHT0090	54N15	Alumina cup gas lens GR7 TIG17-18-26 陶瓷喷嘴 GR7/TIG17-18-26	10
IJHL0016	54N63	Large gas lens insulator torch body TIG17-18-26 加大枪头绝缘帽/TIG17-18-26	10	IJHV0017-05	10N21	Collet ϕ 0.5mm TIG17-18-26 电极夹 ϕ 0.5mm/TIG17-18-26	10
IJHL0018	18CG	Insulator torch body TIG17-18-26 枪头绝缘帽/TIG17-18-26	10	IJHV0017-10	10N22	Collet ϕ 1.0mm TIG17-18-26 电极夹 ϕ 1.0mm/TIG17-18-26	10
IJHL0019	54N01	Insulator torch body gas lens TIG17-18-26 枪头绝缘帽/TIG17-18-26	10	IJHV0017-16	10N23	Collet ϕ 1.6mm TIG17-18-26 电极夹 ϕ 1.6mm/TIG17-18-26	10
IJHL0079	18CG20	Insulator torch body gas lens TIG17-18-26 枪头绝缘帽/TIG17-18-26	10	IJHV0017-20	10N23M	Collet ϕ 2.0mm TIG17-18-26 电极夹 ϕ 2.0mm/TIG17-18-26	10
IJHT0012	10N46	Alumina cup GR8 TIG17-18-26 陶瓷喷嘴 GR8/TIG17-18-26	10	IJHV0017-24	10N24	Collet ϕ 2.4mm TIG17-18-26 电极夹 ϕ 2.4mm/TIG17-18-26	10
IJHT0013	10N45	Alumina cup GR10 TIG17-18-26 陶瓷喷嘴 GR10/TIG17-18-26	10	IJHV0017-32	10N25	Collet ϕ 3.2mm TIG17-18-26 电极夹 ϕ 3.2mm/TIG17-18-26	10
IJHT0014	10N44	Alumina cup GR12 TIG17-18-26 陶瓷喷嘴 GR12/TIG17-18-26	10	IJHV0017-40	54N20	Collet ϕ 4.0mm TIG17-18-26 电极夹 ϕ 4.0mm/TIG17-18-26	10
IJHT0016	10N47	Alumina cup GR7 TIG17-18-26 陶瓷喷嘴 GR7/TIG17-18-26	10	IJHV0018-05	10N21S	Collet ϕ 0.5mm TIG17-18-26 电极夹 ϕ 0.5mm/TIG17-18-26	10
IJHT0018	10N50	Alumina cup GR4 TIG17-18-26 陶瓷喷嘴 GR4/TIG17-18-26	10	IJHV0018-10	10N22S	Collet ϕ 1.0mm TIG17-18-26 电极夹 ϕ 1.0mm/TIG17-18-26	10
IJHT0019	10N49	Alumina cup GR5 TIG17-18-26 陶瓷喷嘴 GR5/TIG17-18-26	10	IJHV0018-16	10N23S	Collet ϕ 1.6mm TIG17-18-26 电极夹 ϕ 1.6mm/TIG17-18-26	10
IJHT0010	10N48	Alumina cup GR6 TIG17-18-26 陶瓷喷嘴 GR6/TIG17-18-26	10	IJHV0018-20	10N23MS	Collet ϕ 2.0mm TIG17-18-26 电极夹 ϕ 2.0mm/TIG17-18-26	10
IJHT0031	57N75	Alumina cup gas lens XL GR6 加大陶瓷喷嘴 GR6	10	IJHV0018-24	10N24S	Collet ϕ 2.4mm TIG17-18-26 电极夹 ϕ 2.4mm/TIG17-18-26	10
IJHT0037	57N74	Alumina cup gas lens XL GR8 加大陶瓷喷嘴 GR8	10	IJHV0018-32	10N25S	Collet ϕ 3.2mm TIG17-18-26 电极夹 ϕ 3.2mm/TIG17-18-26	10
IJHT0038	53N88	Alumina cup gas lens XL GR10 加大陶瓷喷嘴 GR10	10	IJK0022	57Y02	Long back cap TIG17-18-26 长柄帽/TIG17-18-26	10
IJHT0039	53N87	Alumina cup gas lens XL GR12 加大陶瓷喷嘴 GR12	10	IJK0023	57Y04	Short back cap TIG17-18-26 短柄帽/TIG17-18-26	10
IJHT0030	53N89	Alumina cup gas lens XL GR15 加大陶瓷喷嘴 GR15	10	IJK0062	57Y03	Medium back cap TIG17-18-26 中柄帽/TIG17-18-26	10

CONSUMABLES TIG 12 易损件

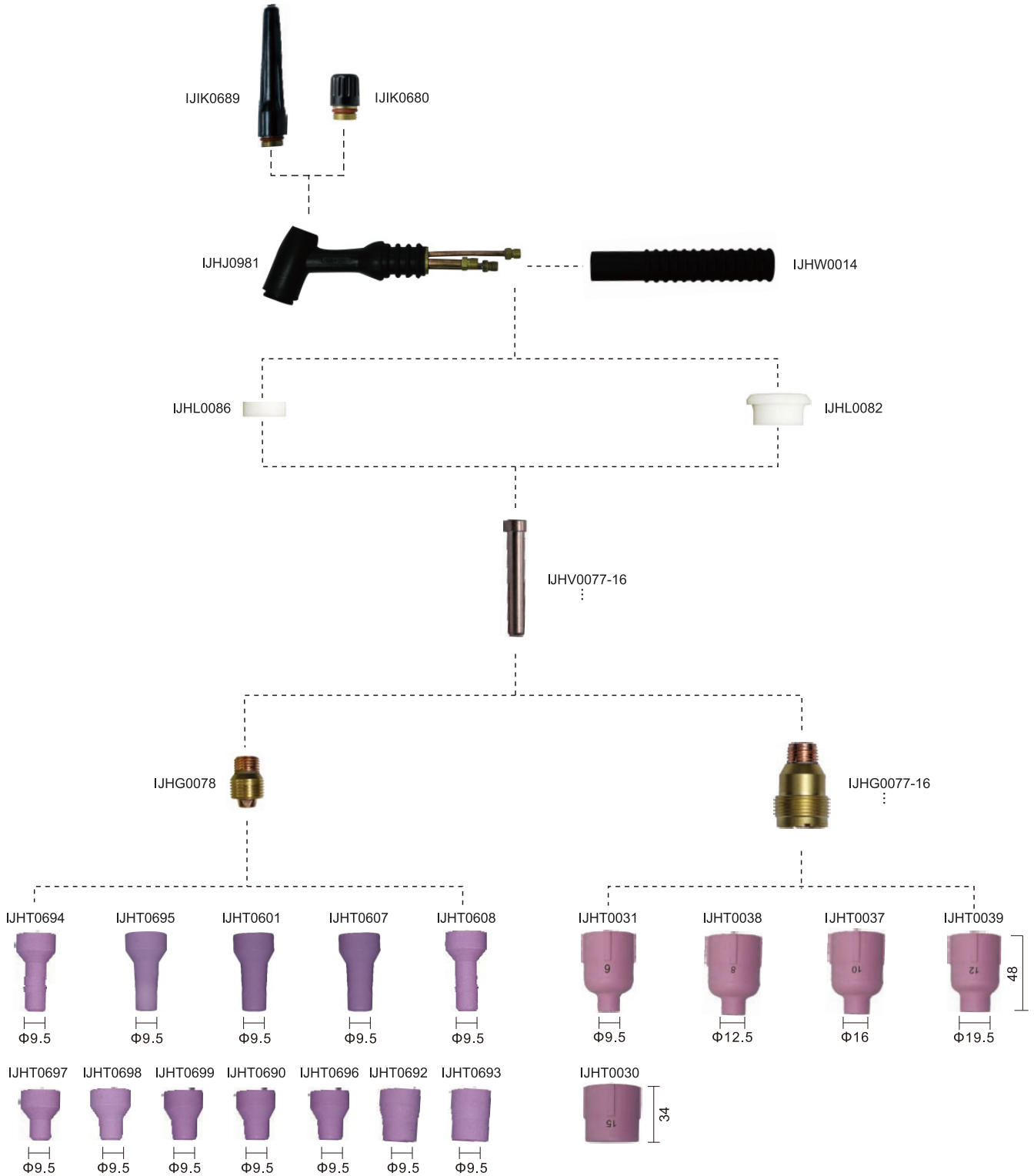

CONSUMABLES TIG 12 易损件



Code	Ref.	Description
IJHG0077-16	11GL16	Collet Body gas lens Φ 1.6 TIG12;气塞连接体 Φ 1.6 TIG12
IJHG0077-24	11GL32	Collet Body gas lens Φ 2.4 TIG12;气塞连接体 Φ 2.4 TIG12
IJHG0077-32	11GL18	Collet Body gas lens Φ 3.2 TIG12;气塞连接体 Φ 3.2 TIG12
IJHG0077-40	11GL53	Collet Body gas lens Φ 4.0 TIG12;气塞连接体 Φ 4.0 TIG12
IJHG0077-48	11GL36	Collet Body gas lens Φ 4.8 TIG12;气塞连接体 Φ 4.8 TIG12
IJHG0078	11WP65	Collet Body(All sizes) TIG12;电极夹座(全尺寸) TIG12
IJHJ0981	WP-12	Torch body, includes nozzle gasket (70°);枪颈/带绝缘垫圈/70°
IJHL0082	12NG	Nozzle gasket;绝缘垫圈
IJHL0086	12GLG	gas lens insulator TIG12;气塞连接体绝缘帽TIG12
IJHT0031	57N75	Alumina Cup gas lens XL GR6;加大gas lens用陶瓷喷嘴 GR6
IJHT0037	57N74	Alumina Cup gas lens XL GR8;加大gas lens用陶瓷喷嘴 GR8
IJHT0038	53N88	Alumina Cup gas lens XL GR10;加大gas lens用陶瓷喷嘴 GR10
IJHT0039	53N87	Alumina Cup gas lens XL GR12;加大gas lens用陶瓷喷嘴 GR12
IJHT0030	53N89	Alumina Cup gas lens XL GR15 short;加大gas lens用陶瓷喷嘴/短款
IJHT0692	14N61-10	Alumina cup/GR10 TIG12;陶瓷喷嘴/GR10 TIG12
IJHT0693	14N61-12	Alumina cup/GR12 TIG12;陶瓷喷嘴/GR12 TIG12
IJHT0694	14N68	Long alumina cup TIG12;加长陶瓷喷嘴 TIG12
IJHT0695	14N69	Long alumina cup TIG12;加长陶瓷喷嘴 TIG12
IJHT0696	14N61	Alumina cup/GR8 TIG12;陶瓷喷嘴/GR8 TIG12
IJHT0697	14N57	Alumina cup/GR4 TIG12;陶瓷喷嘴/GR4 TIG12
IJHT0698	14N58	Alumina cup/GR5 TIG12;陶瓷喷嘴/GR5 TIG12
IJHT0699	14N59	Alumina cup/GR6 TIG12;陶瓷喷嘴/GR6 TIG12
IJHT0690	14N60	Alumina cup/GR7 TIG12;陶瓷喷嘴/GR7 TIG12
IJHT0601	14N70	Long alumina cup TIG12;加长陶瓷喷嘴 TIG12
IJHT0607	14N71	Long alumina cup TIG12;加长陶瓷喷嘴 TIG12
IJHT0608	14N72	Long alumina cup TIG12;加长陶瓷喷嘴 TIG12
IJHV0077-16	85Z14	Collet Φ 1.6 TIG12;电极夹 Φ 1.6 TIG12
IJHV0077-24	85Z15	Collet Φ 2.4 TIG12;电极夹 Φ 2.4 TIG12
IJHV0077-32	85Z16	Collet Φ 3.2 TIG12;电极夹 Φ 3.2 TIG12
IJHV0077-40	85Z17	Collet Φ 4.0 TIG12;电极夹 Φ 4.0 TIG12
IJHV0077-48	85Z18	Collet Φ 4.8 TIG12;电极夹 Φ 4.8 TIG12
IJHV0077-64	85Z19	Collet Φ 6.4 TIG12;电极夹 Φ 6.4 TIG12
IJHW0014	85WP13	Handle TIG12;手柄 TIG12
IJIK0689	56Y45	Long back cap, includes O-ring;长柄帽带O型圈
IJIK0680	56Y44	Short back cap, includes O-ring;短柄帽带O型圈

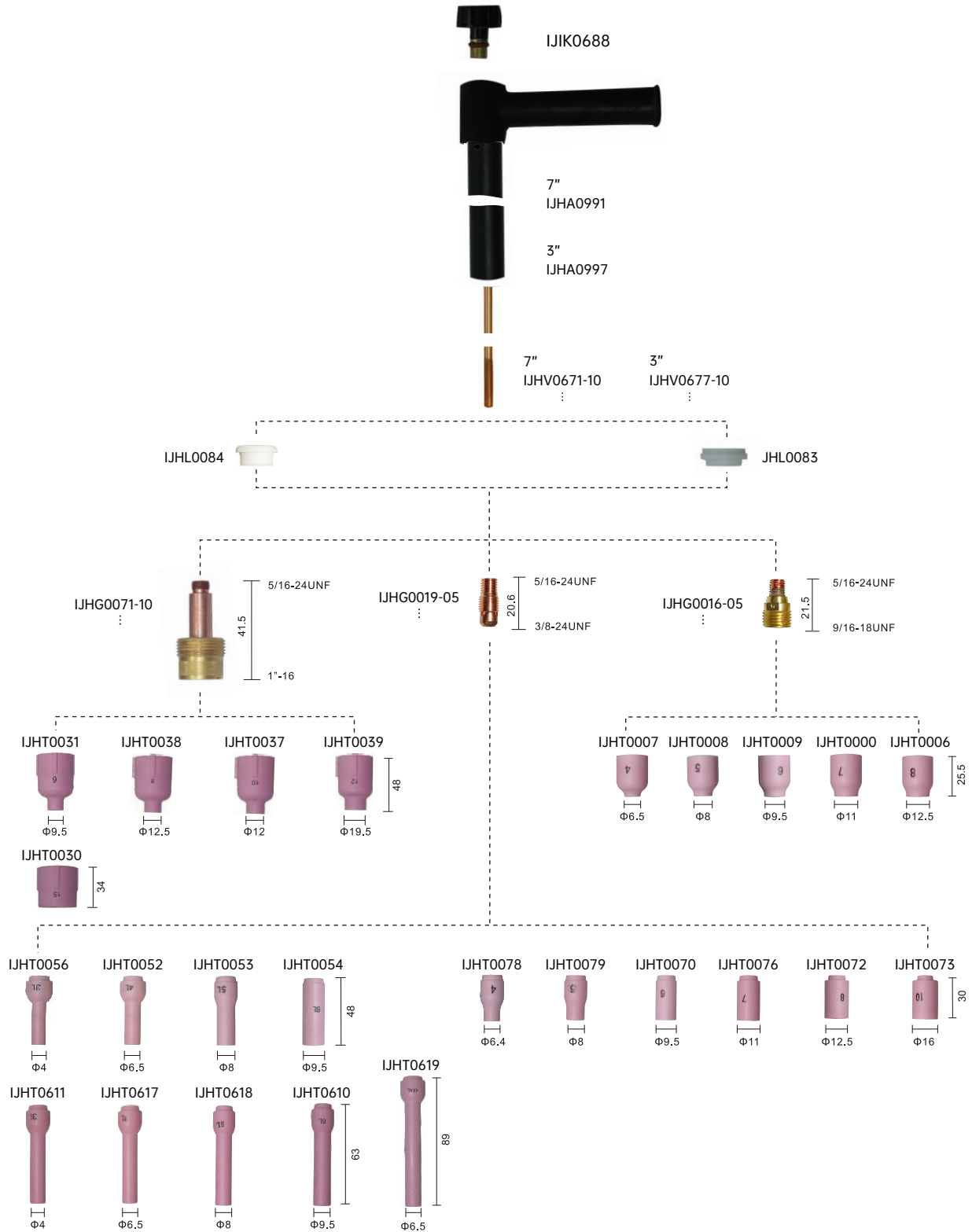

CONSUMABLES TIG 22 易损件



Code	Ref.	Description
IJHG0016-10	45V42	Collet gas lens ϕ 1.0 TIG22-24-24W; 气塞连接体 ϕ 1.0 TIG22-24-24W
IJHG0016-16	45V43	Collet Body gas lens ϕ 1.6 TIG22-24-24W; 气塞连接体 ϕ 1.6 TIG22-24-24W
IJHG0016-24	45V44	Collet Body gas lens ϕ 2.4 TIG22-24-24W; 气塞连接体 ϕ 2.4 TIG22-24-24W
IJHG0016-32	45V45	Collet Body gas lens ϕ 3.2 TIG22-24-24W; 气塞连接体 ϕ 3.2 TIG22-24-24W
IJHG0019-10	13N26	Collet Body ϕ 1.0 TIG9-20-22-25; 电极夹座 ϕ 1.0 TIG9-20-22-25
IJHG0019-16	13N27	Collet Body ϕ 1.6 TIG9-20-22-25; 电极夹座 ϕ 1.6 TIG9-20-22-25
IJHG0019-24	13N28	Collet Body ϕ 2.4 TIG9-20-22-25; 电极夹座 ϕ 2.4 TIG9-20-22-25
IJHG0019-32	13N29	Collet Body ϕ 3.2 TIG9-20-22-25; 电极夹座 ϕ 3.2 TIG9-20-22-25
IJHG0071-10	45V0204S	Extra large gas lens ϕ 1.0 TIG9-20-22-25; 加大气塞连接体 ϕ 1.0 TIG9-20-22-25
IJHG0071-16	45V116S	Extra large gas lens ϕ 1.6 TIG9-20-22-25; 加大气塞连接体 ϕ 1.6 TIG9-20-22-25
IJHG0071-24	45V64S	Extra large gas lens ϕ 2.4 TIG9-20-22-25; 加大气塞连接体 ϕ 2.4 TIG9-20-22-25
IJHG0071-32	995795S	Extra large gas lens ϕ 3.2 TIG9-20-22-25; 加大气塞连接体 ϕ 3.2 TIG9-20-22-25
IJHL0083	22-10	Insulator torch body TIG22; 枪头绝缘帽 TIG22
IJHL0084	54N63-22	Gas lens insulator TIG22; 气塞连接体绝缘帽 TIG22
IJHT0031	57N75	Alumina Cup gas lens XL GR6; 加大gas lens用陶瓷喷嘴 GR6
IJHT0037	57N74	Alumina Cup gas lens XL GR8; 加大gas lens用陶瓷喷嘴 GR8
IJHT0038	53N88	Alumina Cup gas lens XL GR10; 加大gas lens用陶瓷喷嘴 GR10
IJHT0039	53N87	Alumina Cup gas lens XL GR12; 加大gas lens用陶瓷喷嘴 GR12
IJHT0030	53N89	Alumina Cup gas lens XL short; 加大gas lens用陶瓷喷嘴/短款
IJHT0052	796F71	Alumina Cup GR4L TIG9-20-22-25; 长陶瓷喷嘴 GR4L TIG9-20-22-25
IJHT0053	796F72	Alumina Cup GR5L TIG9-20-22-25; 长陶瓷喷嘴 GR5L TIG9-20-22-25
IJHT0054	796F73	Alumina Cup GR6L TIG9-20-22-25; 长陶瓷喷嘴 GR6L TIG9-20-22-25
IJHT0056	796F70	Alumina Cup GR3L TIG9-20-22-25; 长陶瓷喷嘴 GR3L TIG9-20-22-25
IJHT0072	13N12	Alumina Cup GR8 TIG9-20-22-25; 陶瓷喷嘴 GR8 TIG9-20-22-25
IJHT0073	13N13	Alumina Cup GR10 TIG9-20-22-25; 陶瓷喷嘴 GR10 TIG9-20-22-25
IJHT0078	13N08	Alumina Cup GR4 TIG9-20-22-25; 陶瓷喷嘴 GR4 TIG9-20-22-25
IJHT0079	13N09	Alumina Cup GR5 TIG9-20-22-25; 陶瓷喷嘴 GR5 TIG9-20-22-25
IJHT0070	13N10	Alumina Cup GR6 TIG9-20-22-25; 陶瓷喷嘴 GR6 TIG9-20-22-25
IJHT0076	13N11	Alumina Cup GR7 TIG9-20-22-25; 陶瓷喷嘴 GR7 TIG9-20-22-25
IJHT0006	53N61S	Alumina Cup gas lens GR8 TIG22-24-24W; gas lens用陶瓷喷嘴 GR8 TIG22-24-24W
IJHT0007	53N58	Alumina Cup gas lens GR4 TIG22-24-24W; gas lens用陶瓷喷嘴 GR4 TIG22-24-24W
IJHT0008	53N59	Alumina Cup gas lens GR5 TIG22-24-24W; gas lens用陶瓷喷嘴 GR5 TIG22-24-24W
IJHT0009	53N60	Alumina Cup gas lens GR6 TIG22-24-24W; gas lens用陶瓷喷嘴 GR6 TIG22-24-24W
IJHT0000	53N61	Alumina Cup gas lens GR7 TIG22-24-24W; gas lens用陶瓷喷嘴 GR7 TIG22-24-24W
IJHT0611	796F74	Alumina Cup GR3 XL TIG9-20-22-25; 特长陶瓷喷嘴 GR3XL TIG9-20-22-25
IJHT0617	796F75	Alumina Cup GR4 XL TIG9-20-22-25; 特长陶瓷喷嘴 GR4XL TIG9-20-22-25
IJHT0618	796F76	Alumina Cup GR5 XL TIG9-20-22-25; 特长陶瓷喷嘴 GR5XL TIG9-20-22-25
IJHT0610	796F77	Alumina Cup GR6 XL TIG9-20-22-25; 特长陶瓷喷嘴 GR6XL TIG9-20-22-25
IJHV0671-10	22N21AL	Collet ϕ 1.0mm TIG22 7"; 电极夹 ϕ 1.0mm/TIG22 7"
IJHV0671-16	22N22AL	Collet ϕ 1.6mm TIG22 7"; 电极夹 ϕ 1.6mm/TIG22 7"
IJHV0671-24	22N23AL	Collet ϕ 2.4mm TIG22 7"; 电极夹 ϕ 2.4mm/TIG22 7"
IJHV0671-32	22N24AL	Collet ϕ 3.2mm TIG22 7"; 电极夹 ϕ 3.2mm/TIG22 7"
IJHV0677-10	22N21A	Collet ϕ 1.0 TIG22 3"; 电极夹 ϕ 1.0 TIG22 3"
IJHV0677-16	22N22A	Collet ϕ 1.6 TIG22 3"; 电极夹 ϕ 1.6 TIG22 3"
IJHV0677-24	22N23A	Collet ϕ 2.4 TIG22 3"; 电极夹 ϕ 2.4 TIG22 3"
IJHV0677-32	22N24A	Collet ϕ 3.2 TIG22 3"; 电极夹 ϕ 3.2 TIG22 3"
IJHA0991	WP-22A	7"long torch body; 7"长枪体
IJHA0997	WP-22B	3"long torch body; 3"长枪体
IJK0688	22-7	Collet knob, includes O-ring; 短柄帽带O型圈

CONSUMABLES TIG 27 易损件



IJHV0071-10



IJGU0600



IJHG0079-10



IJHL0085



IJAG0061

IJHT0031



IJHT0037



IJHT0038



IJHT0039



IJHT0030



CONSUMABLES TIG 27 易损件



Code	Ref.	Description
IJGU0600	181W89	O-ring;O型圈
IJHG0079-10	49V22	Collet Body gas lens Φ 1.0 TIG27;气塞连接体 Φ 1.0 TIG27
IJHG0079-16	49V23	Collet Body gas lens Φ 1.6 TIG27;气塞连接体 Φ 1.6 TIG27
IJHG0079-24	49V24	Collet Body gas lens Φ 2.4 TIG27;气塞连接体 Φ 2.4 TIG27
IJHG0079-32	49V25	Collet Body gas lens Φ 3.2 TIG27;气塞连接体 Φ 3.2 TIG27
IJHG0079-40	49V26	Collet Body gas lens Φ 4.0 TIG27;气塞连接体 Φ 4.0 TIG27
IJHG0079-48	49V27	Collet Body gas lens Φ 4.8 TIG27;气塞连接体 Φ 4.8 TIG27
IJHG0079-64	49V28	Collet Body gas lens Φ 6.4 TIG27;气塞连接体 Φ 6.4 TIG27
IJHJ0901	WP-27B	Torch head TIG27 20" ;TIG枪头 TIG27 20"
IJHJ0907	WP-27A	Torch head TIG27 9" ;TIG枪头TIG27 9"
IJHL0085	57N56	Gasket;垫圈
IJHT0031	57N75	Alumina cup gas lens XL GR6;加大gas lens用陶瓷喷嘴 GR6
IJHT0037	57N74	Alumina cup gas lens XL GR8;加大gas lens用陶瓷喷嘴 GR8
IJHT0038	53N88	Alumina cup gas lens XL GR10;加大gas lens用陶瓷喷嘴 GR10
IJHT0039	53N87	Alumina cup gas lens XL GR12;加大gas lens用陶瓷喷嘴 GR12
IJHT0030	53N89	Alumina cup gas lens XL short;加大gas lens用陶瓷喷嘴/短款
IJHV0071-10	57N45	Collet Φ 1.0 TIG27;电极夹 Φ 1.0 TIG27
IJHV0071-16	57N46	Collet Φ 1.6 TIG27;电极夹 Φ 1.6 TIG27
IJHV0071-24	57N47	Collet Φ 2.4 TIG27;电极夹 Φ 2.4 TIG27
IJHV0071-32	57N48	Collet Φ 3.2 TIG27;电极夹 Φ 3.2 TIG27
IJHV0071-40	57N49	Collet Φ 4.0 TIG27;电极夹 Φ 4.0 TIG27
IJHV0071-48	57N50	Collet Φ 4.8 TIG27;电极夹 Φ 4.8 TIG27
IJHV0071-64	57N51	Collet Φ 6.4 TIG27;电极夹 Φ 6.4 TIG27
IJAG0061	45V11	Power cable adaptor;电缆适配器7

AIR COOLING CABLES 气冷电缆



3/8" 24 UNF TIG 9/17/24
5/8" 18 UNF TIG 26

Tig 9/17/24 - 2wires

Threading	L (m)	Code
M12x1	4	IJHO0002
	8	IJHO0003
3/8G	4	IJHO0669
	8	IJHO0662

Tig 26 - 2wires

Threading	L (m)	Code
M12x1	4	IJHO0004
	8	IJHO0005
3/8G	4	IJHO0666
	8	IJHO0662

Tig 9/17/24 - 4wires

Threading	L (m)	Code
M12x1	4	IJHO0627
	8	IJHO0628

Tig 26 - 4wires

Threading	L (m)	Code
M12x1	4	IJHO0629
	8	IJHO0620



3/8" 24 UNF TIG 9/17/24
5/8" 18 UNF TIG 26

Tig 9/17/24 - 2wires

Threading	L (m)	Code
M12x1	4	IJHO6002
	8	IJHO6003

Tig 26 - 2wires

Threading	L (m)	Code
M12x1	4	IJHO6004
	8	IJHO6005

Tig 9/17/24 - 4wires

Threading	L (m)	Code
M12x1	4	IJHO6627
	8	IJHO6628

Tig 26 - 4wires

Threading	L (m)	Code
M12x1	4	IJHO6629
	8	IJHO6620



3/8" 24 UNF TIG 9/17/24
5/8" 18 UNF TIG 26

Tig 9/17/24 - 4wires

Threading	L (m)	Code
M12x1	4	IJHO7637
	8	IJHO7638

Tig 26 - 4wires

Threading	L (m)	Code
M12x1	4	IJHO7639
	8	IJHO7630

Tig 9/17/24 - 6wires

Threading	L (m)	Code
M12x1	4	IJHO7627
	8	IJHO7628

Tig 26 - 6wires

Threading	L (m)	Code
M12x1	4	IJHO7629
	8	IJHO7620

Code	Description	Pack
IJHO0002	Complete outer cover 4m M12X1/TIG9-17-24/2 control wires 电缆组/4m/M12X1/TIG9-17-24/二芯控制线	1
IJHO0003	Complete outer cover 8m M12X1/TIG9-17-24/2 control wires 电缆组/8m/M12X1/TIG9-17-24/二芯控制线	1
IJHO0004	Complete outer cover 4m M12X1/TIG26/2 control wires 电缆组/4m/M12X1/TIG26/二芯控制线	1
IJHO0005	Complete outer cover 8m M12X1/TIG26/2 control wires 电缆组/8m/M12X1/TIG26/二芯控制线	1
IJHO0627	Complete outer cover 4m M12X1/TIG9-17-24/4 control wires 电缆组/4m/M12X1/TIG9-17-24/四芯控制线	1
IJHO0628	Complete outer cover 8m M12X1/TIG9-17-24/4 control wires 电缆组/8m/M12X1/TIG9-17-24/四芯控制线	1
IJHO0629	Complete outer cover 4m M12X1/TIG26/4 control wires 电缆组/4m/M12X1/TIG26/四芯控制线	1
IJHO0620	Complete outer cover 8m M12X1/TIG26/4 control wires 电缆组/8m/M12X1/TIG26/四芯控制线	1
IJHO0662	Complete outer cover 8m 3/8G/TIG26/2 control wires 电缆组/8m/3/8G/TIG26/二芯控制线	1
IJHO0666	Complete outer cover 4m 3/8G/TIG26/2 control wires 电缆组/4m/3/8G/TIG26/二芯控制线	1
IJHO0669	Complete outer cover 4m 3/8G/TIG9-17/2 control wires 电缆组/4m/3/8G/TIG9-17/二芯控制线	1
IJHO0660	Complete outer cover 8m 3/8G/TIG9-17/2 control wires 电缆组/8m/3/8G/TIG9-17/二芯控制线	1
IJHO6002	Complete outer cover 4m M12X1/TIG9-17-24/2 control wires/leather tube 电缆组/4m/M12X1/TIG9-17-24/二芯控制线/皮护套	1
IJHO6003	Complete outer cover 8m M12X1/TIG9-17-24/2 control wires/leather tube 电缆组/8m/M12X1/TIG9-17-24/二芯控制线/皮护套	1
IJHO6004	Complete outer cover 4m M12X1/TIG26/2 control wires/leather tube 电缆组/4m/M12X1/TIG26/二芯控制线/皮护套	1
IJHO6005	Complete outer cover 8m M12X1/TIG26/2 control wires/leather tube 电缆组/8m/M12X1/TIG26/二芯控制线/皮护套	1
IJHO6627	Complete outer cover 4m M12X1/TIG9-17-24/4 control wires/leather tube 电缆组/4m/M12X1/TIG9-17-24/四芯控制线/皮护套	1
IJHO6628	Complete outer cover 8m M12X1/TIG9-17-24/4 control wires/leather tube 电缆组/8m/M12X1/TIG9-17-24/四芯控制线/皮护套	1
IJHO6629	Complete outer cover 4m M12X1/TIG26/4 control wires/leather tube 电缆组/4m/M12X1/TIG26/四芯控制线/皮护套	1
IJHO6620	Complete outer cover 8m M12X1/TIG26/4 control wires/leather tube 电缆组/8m/M12X1/TIG26/四芯控制线/皮护套	1
IJHO7627	Complete outer cover 4m M12X1/TIG9-17-24/6 control wires/leather tube/silicon 电缆组/4m/M12X1/TIG9-17-24/六芯控制线/皮护套/硅胶管	1
IJHO7628	Complete outer cover 8m M12X1/TIG9-17-24/6 control wires/leather tube/silicon 电缆组/8m/M12X1/TIG9-17-24/六芯控制线/皮护套/硅胶管	1
IJHO7629	Complete outer cover 4m M12X1/TIG26/6 control wires/leather tube/silicon 电缆组/4m/M12X1/TIG26/六芯控制线/皮护套/硅胶管	1
IJHO7620	Complete outer cover 8m M12X1/TIG26/6 control wires/leather tube/silicon 电缆组/8m/M12X1/TIG26/六芯控制线/皮护套/硅胶管	1
IJHO7637	Complete outer cover 4m M12X1/TIG9-17-24/2 control wires/leather tube/silicon 电缆组/4m/M12X1/TIG9-17-24/二芯控制线/皮护套/硅胶管	1
IJHO7638	Complete outer cover 8m M12X1/TIG9-17-24/2 control wires/leather tube/silicon 电缆组/8m/M12X1/TIG9-17-24/二芯控制线/皮护套/硅胶管	1
IJHO7639	Complete outer cover 4m M12X1/TIG26/2 control wires/leather tube/silicon 电缆组/4m/M12X1/TIG26/二芯控制线/皮护套/硅胶管	1
IJHO7630	Complete outer cover 8m M12X1/TIG26/2 control wires/leather tube/silicon 电缆组/8m/M12X1/TIG26/二芯控制线/皮护套/硅胶管	1

AIR COOLING CABLES 气冷电缆



POWER CABLE



3/8 24 UNF TIG 9/17/24
5/8 18 UNF TIG 26

TIG 9/17/24	Threading	L (m)	Code
M12x1	4		IJHO0016
	8		IJHO0012
3/8G	4		IJHO0605
	8		IJHO0661

TIG 26	Threading	L (m)	Code
M12x1	4		IJHO0013
	8		IJHO0014
3/8G	4		IJHO0667
	8		IJHO0668



3/8 24 UNF TIG 9/17/24
5/8 18 UNF TIG 26

TIG 9/17/24	Threading	L (m)	Code
M12x1	4		IJHO0016-01
	8		IJHO0012-01

TIG 26	Threading	L (m)	Code
M12x1	4		IJHO0013-01
	8		IJHO0014-01

1 PIECE



TIG 9/17/24 - 3/8-24
TIG 26 - 5/8-18

TIG 9/17/24 - 3/8-24RH
TIG 26 - 7/8-14RH

TIG 9/17/24	L (m)	Code
4		IJHO0022
	8	IJHO0023

TIG 26	L (m)	Code
4		IJHO0687
	8	IJHO0001

2 PIECE



TIG 9/17/24 - 3/8-24
TIG 26 - 5/8-18

5/8-18RH

TIG 9/17/24	L (m)	Code
4		IJHO0061
	8	IJHO0067

TIG 26	L (m)	Code
4		IJHO0068
	8	IJHO0069



TIG 9/17/24 - 3/8-24
TIG 26 - 5/8-18

5/8-18RH

TIG 9/17/24	L (m)	Code
4		IJHO0060
	8	IJHO0066

TIG 26	L (m)	Code
4		IJHO0064
	8	IJHO0065

Code	Description	Pack
IJHO0012	Power cable/gas 8m M12X1 TIG9-17-24 气电管 8m M12X1/TIG9-17-24	1
IJHO0012-01	Power cable/gas 8m M12X1 silicon TIG9-17-24 气电管 8m M12X1/TIG9-17-24/硅放管	1
IJHO0013	Power cable/gas 4m M12X1 TIG26 气电管 4m M12X1/TIG26	1
IJHO0013-01	Power cable/gas 4m M12X1 silicon TIG26 气电管 4m M12X1/TIG26/硅放管	1
IJHO0014	Power cable/gas 8m M12X1 TIG26 气电管 8m M12X1/TIG26	1
IJHO0014-01	Power cable/gas 8m M12X1 silicon TIG26 气电管 8m M12X1/TIG26/硅放管	1
IJHO0016	Power cable/gas 4m M12X1 TIG9-17-24 气电管 4m M12X1/TIG9-17-24	1
IJHO0016-01	Power cable/gas 4m M12X1 silicon TIG9-17-24 气电管 4m M12X1/TIG9-17-24/硅放管	1
IJHO0022	Power cable/gas 4m TIG9-17 USA 气电管 4m/TIG9-17/美式	1
IJHO0023	Power cable/gas 8m TIG9-17 USA 气电管 8m/TIG9-17/美式	1
IJHO0061	Power cable/gas 4m 2 pieces TIG9-17 USA 电缆组无外皮 4m/TIG9-17/美式分体	1
IJHO0064	Complete outer cover 4m TIG26 USA 电缆组 4m/TIG26/美式分体	1
IJHO0065	Complete outer cover 8m TIG26 USA 电缆组 8m/TIG26/美式分体	1
IJHO0066	Complete outer cover 8m TIG9-17-24 USA 电缆组 8m/TIG9-17-24/美式分体	1
IJHO0067	Power cable/gas 8m 2 pieces TIG9-17 USA 电缆组无外皮 8m/TIG9-17/美式分体	1
IJHO0068	Power cable/gas 4m 2 pieces TIG26 USA 电缆组无外皮 4m/TIG26/美式分体	1
IJHO0069	Power cable/gas 8m 2 pieces TIG26 USA 电缆组无外皮 8m/TIG26/美式分体	1
IJHO0060	Complete outer cover 4m TIG9-17-24 USA 电缆组 4m/TIG9-17-24/美式分体	1
IJHO0001	Power cable/gas 8m TIG26 USA 气电管 8m/TIG26/美式	1
IJHO0661	Power cable/gas 8m 3/8G TIG9-17 气电管 8m/3/8GTIG9-17	1
IJHO0667	Power cable/gas 4m 3/8G TIG26 气电管 4m/3/8GTIG26	1
IJHO0668	Power cable/gas 8m 3/8G TIG26 气电管 8m/3/8GTIG26	1
IJHO0687	Power cable/gas 4m TIG26 USA 气电管 4m/TIG26/美式	1
IJHO0605	Power cable/gas 4m 3/8G TIG9-17 气电管 4m/3/8GTIG9-17	1

WATER COOLING CABLES 水冷电缆



3/8 28LH-TIG 18



TIG 18 - 2 wiers

L (m)	Code
4	IJHO0028
8	IJHO0029

TIG 18 - 4 wiers

L (m)	Code
4	IJHO0026
8	IJHO0022

3/8 28LH-TIG 18



TIG 18 - 2 wiers

L (m)	Code
4	IJHO7636
8	IJHO7632

TIG 18 - 6 wiers

L (m)	Code
4	IJHO7626
8	IJHO7622

1/4-28 TIG 20/25/24W



TIG 20/25/24W - 2 wiers

L (m)	Code
4	IJHO0020
8	IJHO0026

TIG 20/25/24W - 4 wiers

L (m)	Code
4	IJHO6623
8	IJHO6624

1/4-28 TIG 20/25/24W



TIG 18 - 2 wiers

L (m)	Code
4	IJHO7623
8	IJHO7624

TIG 18 - 6 wiers

L (m)	Code
4	IJHO7633
8	IJHO7634

Code	Description	Pack
IJHO0026	Complete outer cover 8m M12X1 TIG20/2 control wires 电缆组 8m M12X1/TIG20/二芯控制线	1
IJHO0028	Complete outer cover 4m M12X1 TIG18/2 control wires 电缆组 4m M12X1/TIG18/二芯控制线	1
IJHO0029	Complete outer cover 8m M12X1 TIG18/2 control wires 电缆组 8m M12X1/TIG18/二芯控制线	1
IJHO0020	Complete outer cover 4m M12X1 TIG20/2 control wires 电缆组 4m M12X1/TIG20/二芯控制线	1
IJHO6622	Complete outer cover 8m M12X1 TIG18/4 control wires/leather cover 电缆组 8m M12X1/TIG18/四芯控制线/皮护套	1
IJHO6623	Complete outer cover 4m M12X1 TIG 20/4 control wires/leather cover 电缆组 4m M12X1/TIG20/四芯控制线/皮护套	1
IJHO6624	Complete outer cover 8m M12X1 TIG 20/4 control wires/leather cover 电缆组 8m M12X1/TIG20/四芯控制线/皮护套	1
IJHO6626	Complete outer cover 4m M12X1 TIG18/4 control wires/leather cover 电缆组 4m M12X1/TIG18/四芯控制线/皮护套	1
IJHO7622	Complete outer cover 8m M12X1 TIG18/6 control wires/leather cover/silicon 电缆组 8m M12X1/TIG18/六芯控制线/皮护套/硅胶管	1
IJHO7623	Complete outer cover 4m M12X1 TIG20/6 control wires/leather cover/silicon 电缆组 4m M12X1/TIG20/六芯控制线/皮护套/硅胶管	1
IJHO7624	Complete outer cover 8m M12X1 TIG20/6 control wires/leather cover/silicon 电缆组 8m M12X1/TIG20/六芯控制线/皮护套/硅胶管	1
IJHO7626	Complete outer cover 4m M12X1 TIG18/6 control wires/leather cover/silicon 电缆组 4m M12X1/TIG18/六芯控制线/皮护套/硅胶管	1
IJHO7632	Complete outer cover 8m M12X1 TIG18/2 control wires/leather cover/silicon 电缆组 8m M12X1/TIG18/二芯控制线/皮护套/硅胶管	1
IJHO7633	Complete outer cover 4m M12X1 TIG20/2 control wires/leather cover/silicon 电缆组 4m M12X1/TIG20/二芯控制线/皮护套/硅胶管	1
IJHO7634	Complete outer cover 8m M12X1 TIG20/2 control wires/leather cover/silicon 电缆组 8m M12X1/TIG20/二芯控制线/皮护套/硅胶管	1
IJHO7636	Complete outer cover 4m M12X1 TIG18/2 control wires/leather cover/silicon 电缆组 4m M12X1/TIG18/二芯控制线/皮护套/硅胶管	1

GAS CABLE



Threading	L (m)	Code
1/4G	4	IJHO0052
	8	IJHO0053



Threading	L (m)	Code
5/8-18	4	IJHO0030
	8	IJHO0030

WATER CABLE



Threading	L (m)	Code
3/8G	4	IJHO0610
	8	IJHO0616



Threading	L (m)	Code
5/8-18LH	4	IJHO0031
	8	IJHO0037



Threading	L (m)	Code
3/8G	4	IJHO0612
	8	IJHO0613



Threading	L (m)	Code
5/8-18LH	4	IJHO0038
	8	IJHO0039

POWER CABLE

3/8 24LH - TIG 18



1/4-28 - TIG 20/25/24W

Threading	L (m)	Code
M12x1	4	IJHO0048
	8	IJHO0049



TIG 20/25/24W

Threading	L (m)	Code
M12x1	4	IJHO0042
	8	IJHO0043

3/8 24LH - TIG 18



1/4-28 - TIG 20/25/24W

Threading	L (m)	Code
M12x1	4	IJHO0048-01
	8	IJHO0049-01

TIG 20/25/24W

Threading	L (m)	Code
M12x1	4	IJHO0042-01
	8	IJHO0043-01

3/8 24LH - TIG 18



1/4-28 - TIG 20/25/24W

Threading	L (m)	Code
7/8-14	4	IJHO0094
	8	IJHO0607

TIG 20/25/24W

Threading	L (m)	Code
7/8-14	4	IJHO0683
	8	IJHO0684

Code	Description	Pack
IJHO0031	Water tube 4m TIG18 USA 水管 4m/TIG18/美式	1
IJHO0036	Gas tube 8m TIG18-20 USA 气管 8m/TIG18-20/美式	1
IJHO0037	Water tube 8m TIG18 USA 水管 8m/TIG18/美式	1
IJHO0038	Water tube 4m TIG20 USA 水管 4m/TIG20/美式	1
IJHO0039	Water tube 8m TIG20 USA 水管 8m/TIG20/美式	1
IJHO0030	Gas tube 4m TIG18-20 USA 气管 4m/TIG18-20/美式	1
IJHO0042	Power cable 4m M12X1 TIG20 水电线 4m/M12X1/TIG20	1
IJHO0042-01	Power cable 4m M12X1 TIG20/silicon 水电线 4m/M12X1/TIG20/硅胶管	1
IJHO0043	Power cable 8m M12X1 TIG20/silicon 水电线 8m/M12X1/TIG20/硅胶管	1
IJHO0043-01	Power cable 8m M12X1 TIG20 水电线 8m/M12X1/TIG20	1
IJHO0048	Power cable 4m M12X1 TIG18 水电线 4m/M12X1/TIG18	1
IJHO0048-01	Power cable 4m M12X1 TIG18/silicon 水电线 4m/M12X1/TIG18/硅胶管	1
IJHO0049	Power cable 8m M12X1 TIG18 水电线 8m/M12X1/TIG18	1
IJHO0049-01	Power cable 8m M12X1 TIG18/silicon 水电线 8m/M12X1/TIG18/硅胶管	1
IJHO0052	Gas tube 4m 1/4G 气管 4m 1/4G	1
IJHO0053	Gas tube 8m 1/4G 气管 8m 1/4G	1
IJHO0094	Power cable 4m TIG18 USA 水电管 4m/TIG18/美式	1
IJHO0007	Power cable 8m TIG18 USA 水电管 8m/TIG18/美式	1
IJHO0612	Water tube 4m 3/8G TIG20 水管 4m 3/8G/TIG20	1
IJHO0613	Water tube 8m 3/8G TIG20 水管 8m 3/8G/TIG20	1
IJHO0616	Water tube 8m 3/8G TIG18 水管 8m 3/8G/TIG18	1
IJHO0610	Water tube 4m 3/8G TIG18 水管 4m 3/8G/TIG18	1
IJHO0683	Power cable 4m TIG20 USA 水电管/4m/TIG20/美式	1
IJHO0684	Power cable 8m TIG20 USA 水电管/8m/TIG20/美式	1

PLUGS & FITTINGS 接头

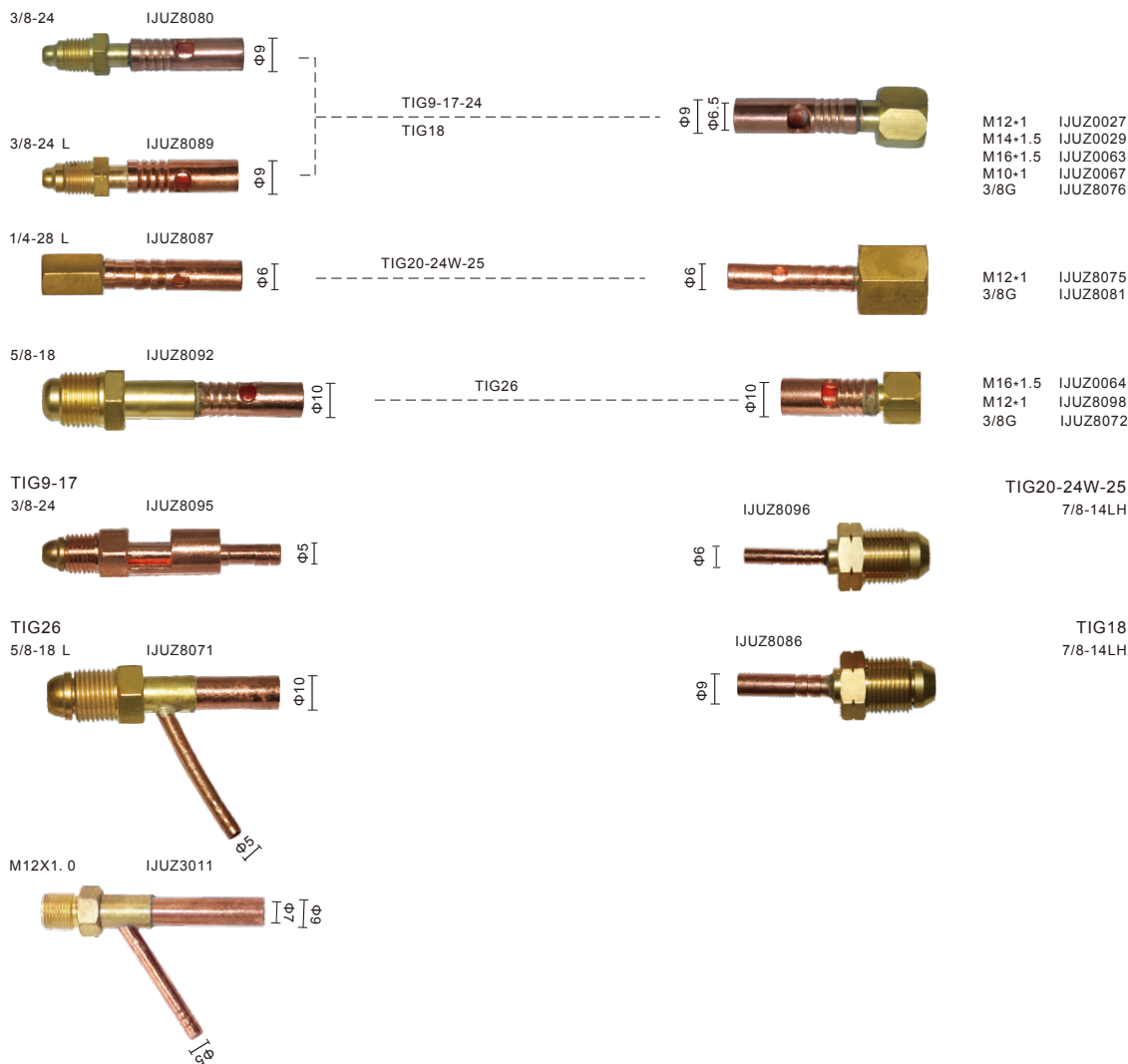

Code	Description	Pack	Code	Description	Pack
IJUZ0027	Cable connector 8mmq/9mm F M12X1 铜绞线接头 8mmq/9mm F M12X1	10	IJUZ8081	Cable connector 4mmq/6mm F 3/8G TIG20 铜绞线接头 4mmq/6mm F 3/8G/TIG20	10
IJUZ0029	Cable connector 8mmq/9mm F M14X1.5 铜绞线接头 8mmq/9mm F M14X1.5	10	IJUZ8086	Cable connector 7/8-14UNF LH TIG18 Back/USA 铜绞线接头 7/8-14UNF LH TIG18/后部/美式	10
IJUZ0063	Cable connector 16mmq/9mm F M16X1.5 铜绞线接头 16mmq/9mm F M16X1.5	10	IJUZ8087	Cable connector 4mmq/6mm F 1/4-28UNF 铜绞线接头 4mmq/6mm F 1/4-28UNF	10
IJUZ0064	Cable connector 25mmq/10mm F M16X1.5 铜绞线接头 25mmq/10mm F M16X1.5	10	IJUZ8089	Cable connector 8mmq/9mm M 3/8-24UNF 铜绞线接头 8mmq/9mm M 3/8-24UNF	10
IJUZ0067	Cable connector 16mmq/9mm F M10X1 铜绞线接头 16mmq/9mm F M10X1	10	IJUZ8080	Cable connector 16mmq/9mm M 3/8-24UNF 铜绞线接头 16mmq/9mm M 3/8-24UNF	10
IJUZ3011	BRAID CONNECTOR; 铜绞线接头TIG(水电气电分离)	10	IJUZ8092	Cable connector 25mmq/10mm M 5/8-18UNF 铜绞线接头 25mmq/10mm M 5/8-18UNF	10
IJUZ8071	Cable connector TIG26 front/USA 2 pcs 铜绞线接头 TIG26/前端美式/气电分离	10	IJUZ8095	Cable connector TIG9-17 front/USA 铜绞线接头 TIG9-17/前端/美式/气电分离	10
IJUZ8072	Cable connector 25mmq/10mm F 3/8G 铜绞线接头 25mmq/10mm F 3/8G	10	IJUZ8096	Cable connector 7/8-14UNF LH TIG20 Back/USA 铜绞线接头 7/8-14UNF LH TIG20/后部/美式	10
IJUZ8075	Cable connector 4mmq/6mm F M12X1 铜绞线接头 4mmq/6mm F M12X1	10	IJUZ8098	Cable connector 25mmq/10mm F M12X1 铜绞线接头 25mmq/10mm F M12X1	10
IJUZ8076	Cable connector 16mmq/9mm F 3/8G 铜绞线接头 16mmq/9mm F 3/8G	10			

PLUGS & FITTINGS 接头



	5/8-18 R	IJAU9011
	5/8-18 L	IJAU9017
	1/4G	IJAU9012
	M16*1.5	IJAU9013
	M10*1	IJAU9019
	5/8-18	IJAU9014
	3/8-24	IJAU9015
	3/8G	IJAU9016
	M12*1	IJAU9018
	9/16-18	IJAU9010
	M12*1(M)/3/8G(F)	IJAU5612
	M12*1(M)/5/8-18(F)	IJAU5613
	M16*1.5(M)/M16*1.5(F)	IJAU5614
	M12*1(M)/1/4G(F)	IJAU5616

Code	Description	Pack
IJAU9011	Connector with hexagon nut 5/8-18UNF 接头带 5/8-18UNF/六角外螺母	10
IJAU9012	Connector with hexagon nut 1/4G 接头带 1/4G/六角内螺母	10
IJAU9013	Connector with hexagon nut M16X1.5 接头带 M16X1.5/六角内螺母	10
IJAU9014	Connector with hexagon nut 5/8-18UNF 接头带 5/8-18UNF/六角内螺母	10
IJAU9015	Connector with hexagon nut 3/8-24UNF 接头带 3/8-24UNF/六角内螺母	10
IJAU9016	Connector with hexagon nut 3/8G 接头带 3/8G/六角内螺母	10
IJAU9017	Connector with hexagon nut 5/8-18UNF LH 接头带 5/8-18UNF LH/六角外螺母	10
IJAU9018	Connector with hexagon nut M12X1 接头带 M12X1/六角内螺母	10
IJAU9019	Connector with hexagon nut M10X1 接头带 M10X1/六角内螺母	10
IJAU9010	Connector with hexagon nut 9/16-18 接头带 9/16-18/六角内螺母	10
IJAU5612	Connetecing adaptor M12X1-3/8G 转换接头 M12X1-3/8G	10
IJAU5613	Connetecing adaptor M12x1 5/8-18UNF 转换接头 M12x1 5/8-18UNF	10
IJAU5614	Connetecing adaptor M16X1.5-M16X1.5 F 转换接头 M16X1.5-M16X1.5 F	10
IJAU5616	Connetecing adaptor M12x1 1/4G 转换接头 M12x1 1/4G	10

GAS FITTINGS

Code	Description	Pack
IJIR0768	Connector 2 holes 两芯航插	10
IJIR0748	Connector 3 holes 三芯航插	5
IJIR0767I	Connector 5 holes 五芯航插	5
IJAY0074	Centre adaptor torchside PLASMA without back box and pins 等离子中央插头/不带把套和针	10

ELECTRIC PLUGS

TORCH HANDLES 手柄

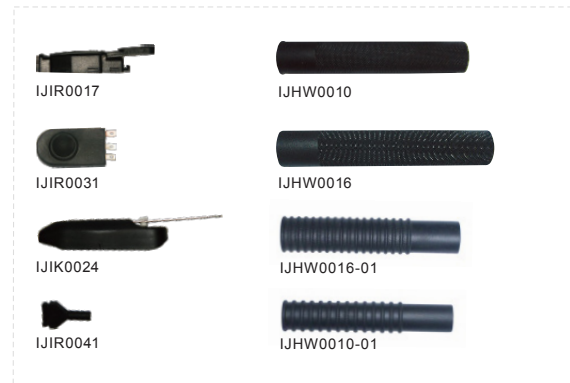

Code	Description	Pack
IJGU0864	Screw 3X8mm 螺丝3X8mm	10
IJHW0016	Handle TIG18-26 直筒手柄/TIG18-26	10
IJHW0010	Handle TIG9-17 直筒手柄/TIG9-17	10
IJHW0016-01	HANDLE RIBBED TIG 18-26/D22.3mm 直筒带棱手柄 TIG18-26/孔径 D22.3mm	10
IJHW0010-01	HANDLE RIBBED TIG 9-17/D15.1mm 直筒带棱手柄 TIG9-17/孔径 D15.1mm	10
IJHW0051	Ergotig handle/grey 尔高TIG手柄/灰色	10
IJHW0057	Ergotig handle/blue 尔高TIG手柄/蓝色	10
IJHW0058	Ergotig handle/red 尔高TIG手柄/红色	10
IJHW0059	Ergotig handle/black 尔高TIG手柄/黑色	10
IJHW0691	Ergotig handle/grey/black/grip 尔高TIG手柄/灰色/黑色/防滑皮	10
IJHW0697	ERGOTIG HANDLE GREY/BLUE 尔高TIG手柄/灰色/蓝色/防滑皮	10
IJHW0699	ERGOTIG HANDLE BLACK/RED GRIP 尔高TIG手柄/黑色/红色/防滑皮	10
IJHW0690	ERGOTIG HANDLE BLUE/YELLOW GRIP 尔高TIG手柄/蓝色/黄色/防滑皮	10
IJK0024	TIG guns with the tail switch button TIG 长尾开关按钮	10
IJK0507	PUSHBUTTON FOR TIG GRIP HANDLE/SINGLE/ORANGE/SOFT 开关按钮/TIG防滑手柄/单开关/橙色/3代	10
IJK0508	PUSHBUTTON FOR TIG GRIP HANDLE/DOUBLE/ORANGE/SOFT 开关按钮/TIG防滑手柄/双开关/橙色/3代	10
IJK0509	COVER FOR TIG GRIP HANDLE/FOUR 开关盖/TIG防滑手柄/四开关	10
IJK0500	COVER FOR TIG GRIP HANDLE/BLACK 开关盖/TIG防滑手柄/黑色	10
IJK0812	Doublet switch Red TIG双开关按钮/红色	10
IJK0816	Sintig switch Orange TIG单开关按钮/橙色	10
IJK0819	Reduction for TIG9-17 适配环/TIG9-17	10
IJK0871	Small joint TIG9-17-20 小球节/TIG9-17-20	10
IJK0877	Big joint TIG18-26 大球节/TIG18-26	10
IJK0878	Small spring support for TIG9-17-20 小弹簧支撑/TIG9-17-20	10
IJK0879	Big spring support for TIG18-26 大弹簧支撑/TIG18-26	10
IJK0804	Small TIG joint TIG用球节套件/小	10
IJK0805	Big TIG joint TIG用球节套件/大	10
IJK0991	SET FOR DOUBLE SWITCHES/ORANGE/WINN 按键套件/双开关/橙色/WINN	10
IJK0997	SET FOR FOUR SWITCHES/ORANGE/WINN 按键套件/四开关/橙色/WINN	10
IJIR0017	Microswitch TIG TIG用外绑式微动开关	10
IJIR0031	Microswitch TIG 微动开关	10
IJIR0041	Connector for SW1 连接件/配合SW1	10
IJIR0182	Double switches with pcb TIG用双开关(含线路板)	10
IJIR0186	Single switches with pcb TIG用单开关(含线路板)	10
IJIR0101	DOUBLE SWITCHES WITH PCB/WINN TIG 用双开关(含线路板)/WINN	10
IJIR0107	FOUR SWITCHES WITH PCB/WINN TIG 用四开关(含线路板)/WINN	10
IJIR0109	SINGLE SWITCH WITH PCB/NEW VERSION TIG 用单开关(含线路板)/新式	10
IJIR0100	DOUBLE SWITCHES WITH PCB/NEW VERSION TIG 用双开关(含线路板)/新式	10

TORCH HEADS 枪头



More water cooled system

Type	Code	Ref.	Description	Pack
TIG 9	IJHA0015	WP-9	Torch Head TIG9 TIG9 枪头	1
	IJHA0071	WP-9V	WP-9 1 Torch Head With Valve TIG9 TIG9 枪头/带阀门	1
	IJHA0615	WP-9F	WP-9V Torch Head TIG9 Flex TIG9 柔性枪头	1
	IJHA0671	WP-9FV	WP-9F Torch Head With Valve TIG9 Flex TIG9 柔性枪头/带阀门	1
	IJHA6011	WP-9P	Auto Torch Head TIG9 TIG9 自动枪头	1
TIG 17	IJHA0073	WP-17	Torch Head TIG17 TIG17 枪头	1
	IJHA0088	WP-17F	Torch Head TIG17 Flex TIG17 柔性枪头	1
	IJHA0673	WP-17V	Torch Head With Valve TIG17 TIG17 枪头/带阀门	1
	IJHA0674	WP-17FV	Torch Head With Valve TIG17 Flex TIG17 柔性阀门	1
	IJHA6018	WP-17P	Auto Torch Head TIG17 TIG17 自动枪头	1
TIG 18	IJHJ0074	WP-18	Torch HeadTIG18 TIG18 枪头	1
	IJHJ0075	WP-18V	Torch Head With Valve TIG18 TIG18 枪头/带阀门	1
	IJHJ0479	WP-18SC	Torch Head TIG18 HC TIG18 枪头/HC	1
	IJHJ0674	WP-18F	Torch Head TIG18 Flex TIG18 柔性枪头	1
	IJHJ0675	WP-18FV	Torch Head With Valve TIG18 Flex TIG18 柔性枪头/带阀门	1
	IJHJ6017	WP-18P	Auto Torch Head TIG18 TIG18 自动枪头	1
	TIG 20	IJHJ0081	WP-20	Torch Head TIG9 TIG9 枪头
IJHJ0087		WP-20V	WP-9 1 Torch Head With Valve TIG9 TIG9 枪头/带阀门	1
IJHJ0478		WP-20SC	WP-9V Torch Head TIG9 Flex TIG9 柔性枪头	1
IJHJ0781		WP-20F	WP-9F Torch Head With Valve TIG9 Flex TIG9 柔性枪头/带阀门	1
IJHJ6011		WP-20P	Auto Torch Head TIG9 TIG9 自动枪头	1
TIG 24	IJHJ0080	WP-24W	Torch Head TIG24W TIG24W 枪头	1
	IJHJ0780	WP-24WF	Torch Head TIG24 W Flex TIG24W 柔性枪头	1
	IJHA0080	WP-24	Torch Head TIG24 TIG24 枪头	1
	IJHA0780	WP-24F	Torch Head TIG24 Flex TIG24柔性枪头	1
TIG 25	IJHJ0086	WP-25	Torch Head TIG25 TIG25 枪头	1
TIG 26	IJHA0082	WP-26	Torch Head TIG26 TIG26 枪头	1
	IJHA0083	WP-26V	Torch Head TIG26 Flex TIG26 柔性枪头	1
	IJHA0682	WP-26F	Torch Head With Valve TIG26 TIG26 枪头/带阀门	1
	IJHA0683	WP-26FV	Torch Head With Valve TIG26 Flex TIG26 柔性枪头/带阀门	1
	IJHA6017	WP-26P	Auto Torch Head TIG26 TIG26 自动枪头	1
TIG 24	IJK0027	VS-2	Valve TIG9/17 阀门 TIG9/17	1
	IJK0028	VS-1	Valve TIG26 阀门 TIG26	1



IGCCC-3-10



IGCCC-3-25



IGCCC-4-22



IGCAP-9001



IGCAP-9002



IGCAP-9000



IGCAP-9008

Code	Ref.	Description	Pack
IGCCC-3-10		TIG Sheathing Nylon CC-3-10 尼龙护套	1
IGCCC-3-25		TIG Sheathing Nylon CC-3-25 尼龙护套	1
IGCCC-4-22		TIG Sheathing Nylon CC-4-22 尼龙护套	1
IGCAP-9001		Golden Cowhide Cable Cover 金黄色焊枪保护套 10CMx350CM	1
IGCAP-9002		Canvas Cable/Hose Cover 阻燃帆布焊枪保护套 10CMx350CM	1
IGCAP-9000		Charcoal-brown Cowhide Cable Cover 炭啡色全皮焊枪保护套 10CMx350CM	1
IGCAP-9008		Black Grain Pigskin Cable Cover 黑色猪青皮焊枪保护套 10CMx350CM	1

ELECTRONIC PLUG 电气插头



IJIR0761
M19×1.0



15.4mm



2PIN

IJIR0768
M16×1.0



12.7mm



2PIN

IJIR0700
M16×1.0



12.7mm



3PIN

IJIR0765
M16×1.0



12.7mm



5PIN

IJIR0883



12.7mm



6PIN

IJIR0720
M16×1.0



12.7mm



7PIN

IJIR0896



21mm



2PIN

IJIR0806



12.7mm



5PIN

IJIR0769



16mm



3PIN

IJIR0763



17.5mm



2PIN

IJIR0763-01



17.5mm



4PIN

IJIR0747
1-1/4-18
UNEF-2B



26.6mm



14PIN

IJIR0741
1-1/4-18
UNEF-2B



26.6mm



14PIN

IJIR0760



24.8mm



2PIN

IJIR0762



24.8mm



3PIN

IJIR0753



12.5mm



4PIN

IJIR0702



12.5mm



8PIN

IJIR0726
15/16-20



23.5mm



10PIN

IJIR0703
15/16-20



21.5mm



14PIN

IJAY0074



IJIR0748



20.2mm



3PIN

IJIR0767



20.2mm



5PIN

IJIR0731



20.2mm



7PIN

IJIR0732
M29×1.0



24.8mm



6PIN

IJIR0941-01



6PIN

IJIR0941



6PIN

JIR0721



17.5mm



7PIN

IJIR0865



17.5mm



4PIN

JIR0151



15.7mm



4PIN

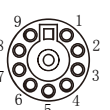

14PIN

ELECTRONIC PLUG 电气插头



Code	Ref.	Description	Pack
IJIR0761		Connector 2 holes 两芯航插	10
IJIR0768		Connector 2 holes 两芯航插	10
IJIR0700		Connector 3 holes 三芯航插	10
IJIR0765		Connector 5 holes 五芯航插	10
IJIR0883		CONNNECTOR 6 HOLES/YS-16 六芯航插/ YS-16	10
IJIR0720		Connector 7 holes 七芯航插	10
IJIR0896		CONNNECTOR 2 HOLES/YS-16 二芯航插/ YS- 16 /针式	10
IJIR0806		CONNECTOR 5 HOLES/BINDER 五芯航插/宾德	10
IJIR0769		Connector 3 holes 三芯航插	10
IJIR0763		Connector 2 holes 两芯航插	10
IJIR0763-01		Connector 4 holes 四芯航插	10
IJIR0741		Connector 14 holes 十四芯航插	10
IJIR0747		Connector 14 holes 十四芯航插	10
IJIR0760		Connector 2 holes 两芯航插	10
IJIR0762		Connector 3 holes/With connectors/Pan 三芯航插/带控制线/松下	10
IJIR0753		Connector 4 holes/Meller 四芯航插/米勒	10
IJIR0702		Connector 8 holes 八芯航插	10
IJIR0726		Connector 10 holes 十芯航插	10
IJIR0703		Connector 14 holes 十四芯航插	10
IJIR0748		Connector 3 holes 三芯扁航插	10
IJIR0767		Connector 5 holes 五芯扁航插	10
IJIR0731		Connector 7 holes 七芯航插	10
IJIR0732		Connector 6 holes 六芯航插	10
IJIR0941-01		CONNNECTOR 6 HOLES/PAN/M 六芯航插/松下/公	10
IJIR0941		CONNNECTOR 6 HOLES/PAN/F 六芯航插/松下/母	10
IJIR0721		Connector 7 holes 七芯航插	10
IJIR0865		Connector 4 holes 四芯航插	10
IJIR0151		Connector CX16-4T 四芯航插反坐	10
IJAY0074		Centre adaptor torchside PLASMA without back box and pins 等离子中央插头/不带把套和针	10

CABLE & PANEL CONNECTORS 快速插头

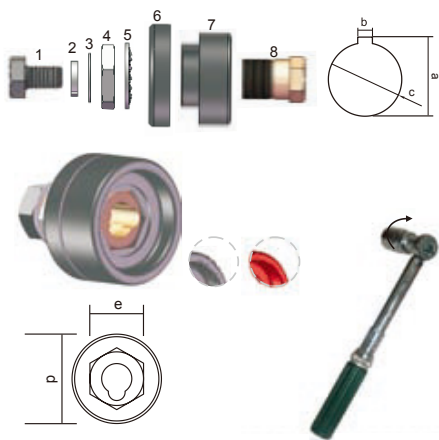

mm ²	Code	amp.max	N-m	a	b	c	d	e
10-25	IJTR0091	200A	6	23	6	20	∅ 32	14
10-25	IJTR5091	200A	6	23	6	20	∅ 32	14
35-70	IJTR0097	400A	18	34	6.5	30	∅ 48	21
35-70	IJTR0064	400A	13	33	6.3	30	∅ 38	21
70-95	IJTR0065	500A	20	33	6.3	30	∅ 38	24
70-95	IJTR0098	500A	25	34	6.5	30	∅ 48	24

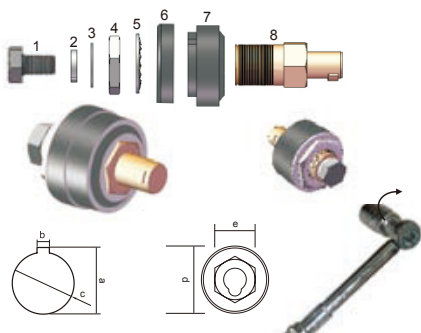

mm ²	Code	amp.max	N-m	a	b	c	d	e
10-25	IJTR0071	200A	6	23	6	20	∅ 32.5	14
35-70	IJTR0038	400A	18	23	6	30.5	∅ 38	21
70-95	IJTR0039	500A	25	33	6	30.5	∅ 38	24



mm ²	Code	amp.max	e
10-25	IJTR0081	200A	14
10-25	IJTR5081	200A	14
35	IJTR0087	250A	21
50	IJTR0088	300A	21
70	IJTR0086	400A	21
70	IJTR0089	400A	24
95	IJTR0080	500A	24

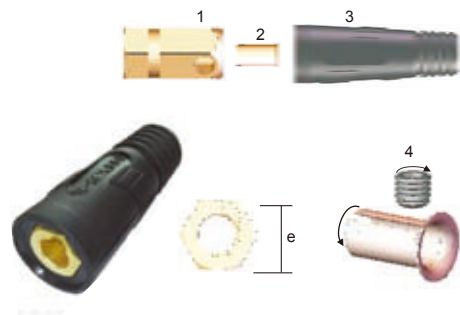

mm ²	Code	amp.max	e
10-25	IJTR0001	200A	14
35	IJTR0007	250A	21
50	IJTR0008	300A	21
70	IJTR0023	400A	21
70	IJTR0009	400A	24
95	IJTR0000	500A	24

CABLE & PANEL CONNECTORS 快速插头

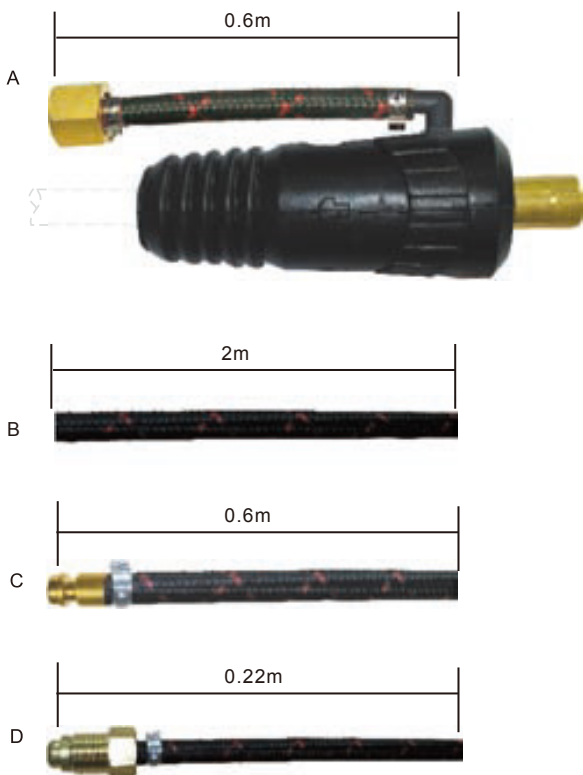

Code	Description	Pack
IJTR0043	Connector with hexagon nut 5/8-18UNF 接头带 5/8-18UNF/六角外螺母	10
IJTR0043-01	Connector with hexagon nut 1/4G 接头带 1/4G/六角内螺母	10
IJTR0044	Connector with hexagon nut M16X1.5 接头带 M16X1.5/六角内螺母	10
IJTR0034-01	Connector with hexagon nut 5/8-18UNF 接头带 5/8-18UNF/六角内螺母	10
IJTR0045	Connector with hexagon nut 3/8-24UNF 接头带 3/8-24UNF/六角内螺母	10
IJTR0045-01	Connector with hexagon nut 3/8G 接头带 3/8G/六角内螺母	10
IJTR0033	Connector with hexagon nut 5/8-18UNF LH 接头带 5/8-18UNF LH/六角外螺母	10
IJTR0033-01	Connector with hexagon nut M12X1 接头带 M12X1/六角内螺母	10
IJTR0034	Connector with hexagon nut M10X1 接头带 M10X1/六角内螺母	10
IJTR0034-01	Connector with hexagon nut 9/16-18 接头带 9/16-18/六角内螺母	10
IJTR0035	Connetecing adaptor M12X1-3/8G 转换接头 M12X1-3/8G	10
IJTR0035-01	Connetecing adaptor M12x1 5/8-18UNF 转换接头 M12x1 5/8-18UNF	10
IJTR6686	Connetecing adaptor M16X1.5-M16X1.5 F 转换接头 M16X1.5-M16X1.5 F	10
IJTR6686-01	Connetecing adaptor M12x1 1/4G 转换接头 M12x1 1/4G	10
IJTR0047	Connector with hexagon nut 3/8G 接头带 3/8G/六角内螺母	10
IJTR0047-01	Connector with hexagon nut 5/8-18UNF LH 接头带 5/8-18UNF LH/六角外螺母	10
IJTR0051	Connector with hexagon nut M12X1 接头带 M12X1/六角内螺母	10
IJTR0051-01	Connector with hexagon nut M10X1 接头带 M10X1/六角内螺母	10
IJTR0041	Connector with hexagon nut 9/16-18 接头带 9/16-18/六角内螺母	10
IJTR0041-01	Connetecing adaptor M12X1-3/8G 转换接头 M12X1-3/8G	10
IJTR0049	Connetecing adaptor M12x1 5/8-18UNF 转换接头 M12x1 5/8-18UNF	10
IJTR0049-01	Connetecing adaptor M16X1.5-M16X1.5 F 转换接头 M16X1.5-M16X1.5 F	10

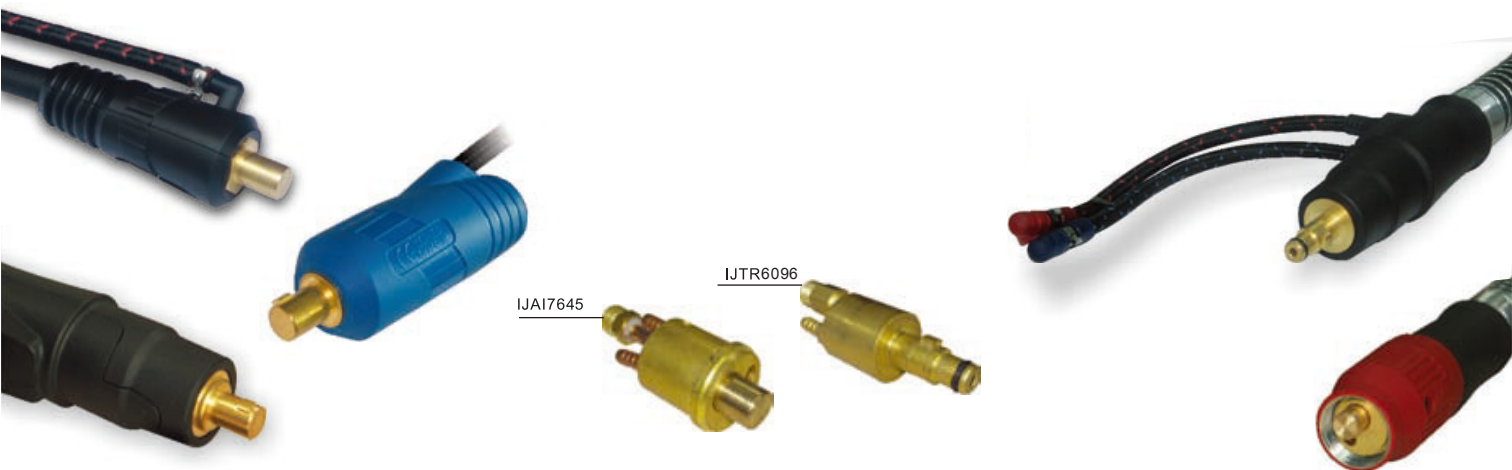

TUNGSTEN ELECTRODES 钨棒



Code	Description	Pack
IJHC0017-10	Pure tungsten Φ 1.0X150mm Green;纯钨/绿色	10
IJHC0017-16	Pure tungsten Φ 1.6X150mm Green;纯钨/绿色	10
IJHC0017-20	Pure tungsten Φ 2.0X150mm Green;纯钨/绿色	10
IJHC0017-24	Pure tungsten Φ 2.4X150mm Green;纯钨/绿色	10
IJHC0017-30	Pure tungsten Φ 3.0X150mm Green;纯钨/绿色	10
IJHC0017-32	Pure tungsten Φ 3.2X150mm Green;纯钨/绿色	10
IJHC0017-40	Pure tungsten Φ 4.0X150mm Green;纯钨/绿色	10
IJHC0017-48	Pure tungsten Φ 4.8X150mm Green;纯钨/绿色	10
IJHC0018-10	Pure tungsten Φ 1.0X175mm Green;纯钨/绿色	10
IJHC0018-16	Pure tungsten Φ 1.6X175mm Green;纯钨/绿色	10
IJHC0018-20	Pure tungsten Φ 2.0X175mm Green;纯钨/绿色	10
IJHC0018-24	Pure tungsten Φ 2.4X175mm Green;纯钨/绿色	10
IJHC0018-30	Pure tungsten Φ 3.0X175mm Green;纯钨/绿色	10
IJHC0018-32	Pure tungsten Φ 3.2X175mm Green;纯钨/绿色	10
IJHC0018-40	Pure tungsten Φ 4.0X175mm Green;纯钨/绿色	10
IJHC0018-48	Pure tungsten Φ 4.8X175mm Green;纯钨/绿色	10
IJHC0018-64	Pure tungsten Φ 6.4X175mm Green;纯钨/绿色	10
IJHC0019-10	Tungsten Th WT20 Φ 1.0X150mm Red;钨钍/红色	10
IJHC0019-16	Tungsten Th WT20 Φ 1.6X150mm Red;钨钍/红色	10
IJHC0019-20	Tungsten Th WT20 Φ 2.0X150mm Red;钨钍/红色	10
IJHC0019-24	Tungsten Th WT20 Φ 2.4X150mm Red;钨钍/红色	10
IJHC0019-30	Tungsten Th WT20 Φ 3.0X150mm Red;钨钍/红色	10
IJHC0019-32	Tungsten Th WT20 Φ 3.2X150mm Red;钨钍/红色	10
IJHC0019-40	Tungsten Th WT20 Φ 4.0X150mm Red;钨钍/红色	10
IJHC0019-48	Tungsten Th WT20 Φ 4.8X150mm Red;钨钍/红色	10
IJHC0010-10	Tungsten Th WT20 Φ 1.0X175mm Red;钨钍/红色	10
IJHC0010-16	Tungsten Th WT20 Φ 1.6X175mm Red;钨钍/红色	10
IJHC0010-20	Tungsten Th WT20 Φ 2.0X175mm Red;钨钍/红色	10
IJHC0010-24	Tungsten Th WT20 Φ 2.4X175mm Red;钨钍/红色	10
IJHC0010-30	Tungsten Th WT20 Φ 3.0X175mm Red;钨钍/红色	10
IJHC0010-32	Tungsten Th WT20 Φ 3.2X175mm Red;钨钍/红色	10
IJHC0010-40	Tungsten Th WT20 Φ 4.0X175mm Red;钨钍/红色	10
IJHC0010-48	Tungsten Th WT20 Φ 4.8X175mm Red;钨钍/红色	10
IJHC0010-64	Tungsten Th WT20 Φ 6.4X175mm Red;钨钍/红色	10
IJHC0016-10	Tungsten Th WT20 Φ 1.0X178mm Red;钨钍/红色	10
IJHC0016-16	Tungsten Th WT20 Φ 1.6X178mm Red;钨钍/红色	10
IJHC0016-20	Tungsten Th WT20 Φ 2.0X178mm Red;钨钍/红色	10
IJHC0016-24	Tungsten Th WT20 Φ 2.4X178mm Red;钨钍/红色	10
IJHC0016-30	Tungsten Th WT20 Φ 3.0X178mm Red;钨钍/红色	10
IJHC0016-32	Tungsten Th WT20 Φ 3.2X178mm Red;钨钍/红色	10
IJHC0016-40	Tungsten Th WT20 Φ 4.0X178mm Red;钨钍/红色	10
IJHC0016-48	Tungsten Th WT20 Φ 4.8X178mm Red;钨钍/红色	10
IJHC0016-64	Tungsten Th WT20 Φ 6.4X178mm Red;钨钍/红色	10
IJHC0013-10	Tungsten Ce WC20 Φ 1.0X150mm Grey;铈钨/灰色	10
IJHC0013-16	Tungsten Ce WC20 Φ 1.6X150mm Grey;铈钨/灰色	10
IJHC0013-20	Tungsten Ce WC20 Φ 2.0X150mm Grey;铈钨/灰色	10
IJHC0013-24	Tungsten Ce WC20 Φ 2.4X150mm Grey;铈钨/灰色	10
IJHC0013-30	Tungsten Ce WC20 Φ 3.0X150mm Grey;铈钨/灰色	10
IJHC0013-32	Tungsten Ce WC20 Φ 3.2X150mm Grey;铈钨/灰色	10
IJHC0013-40	Tungsten Ce WC20 Φ 4.0X150mm Grey;铈钨/灰色	10
IJHC0013-48	Tungsten Ce WC20 Φ 4.8X150mm Grey;铈钨/灰色	10
IJHC0013-64	Tungsten Ce WC20 Φ 6.4X150mm Grey;铈钨/灰色	10

Code	Description	Pack
IJHC0014-10	Tungsten Ce WC20 Φ 1.0X175mm Grey;铈钨/灰色	10
IJHC0014-16	Tungsten Ce WC20 Φ 1.6X175mm Grey;铈钨/灰色	10
IJHC0014-20	Tungsten Ce WC20 Φ 2.0X175mm Grey;铈钨/灰色	10
IJHC0014-24	Tungsten Ce WC20 Φ 2.4X175mm Grey;铈钨/灰色	10
IJHC0014-30	Tungsten Ce WC20 Φ 3.0X175mm Grey;铈钨/灰色	10
IJHC0014-32	Tungsten Ce WC20 Φ 3.2X175mm Grey;铈钨/灰色	10
IJHC0014-40	Tungsten Ce WC20 Φ 4.0X175mm Grey;铈钨/灰色	10
IJHC0014-48	Tungsten Ce WC20 Φ 4.8X175mm Grey;铈钨/灰色	10
IJHC0014-64	Tungsten Ce WC20 Φ 6.4X175mm Grey;铈钨/灰色	10
IJHC0012-10	Tungsten Zr WZ8 Φ 1.0X175mm White;锆钨/白色	10
IJHC0012-16	Tungsten Zr WZ8 Φ 1.6X175mm White;锆钨/白色	10
IJHC0012-24	Tungsten Zr WZ8 Φ 2.4X175mm White;锆钨/白色	10
IJHC0012-32	Tungsten Zr WZ8 Φ 3.2X175mm White;锆钨/白色	10
IJHC0012-40	Tungsten Zr WZ8 Φ 4.0X175mm White;锆钨/白色	10
IJHC0012-48	Tungsten Zr WZ8 Φ 4.8X175mm White;锆钨/白色	10
IJHC0012-64	Tungsten Zr WZ8 Φ 6.4X175mm White;锆钨/白色	10
IJHC0015-10	Tungsten Th WT10 Φ 1.0X150mm Yellow;钨钍/黄色	10
IJHC0015-16	Tungsten Th WT10 Φ 1.6X150mm Yellow;钨钍/黄色	10
IJHC0015-20	Tungsten Th WT10 Φ 2.0X150mm Yellow;钨钍/黄色	10
IJHC0015-24	Tungsten Th WT10 Φ 2.4X150mm Yellow;钨钍/黄色	10
IJHC0015-30	Tungsten Th WT10 Φ 3.0X150mm Yellow;钨钍/黄色	10
IJHC0015-32	Tungsten Th WT10 Φ 3.2X150mm Yellow;钨钍/黄色	10
IJHC0015-40	Tungsten Th WT10 Φ 4.0X150mm Yellow;钨钍/黄色	10
IJHC0015-48	Tungsten Th WT10 Φ 4.8X150mm Yellow;钨钍/黄色	10
IJHC0071-10	Tungsten Th WT10 Φ 1.0X175mm Yellow;钨钍/黄色	10
IJHC0071-16	Tungsten Th WT10 Φ 1.6X175mm Yellow;钨钍/黄色	10
IJHC0071-20	Tungsten Th WT10 Φ 2.0X175mm Yellow;钨钍/黄色	10
IJHC0071-24	Tungsten Th WT10 Φ 2.4X175mm Yellow;钨钍/黄色	10
IJHC0071-30	Tungsten Th WT10 Φ 3.0X175mm Yellow;钨钍/黄色	10
IJHC0071-32	Tungsten Th WT10 Φ 3.2X175mm Yellow;钨钍/黄色	10
IJHC0071-40	Tungsten Th WT10 Φ 4.0X175mm Yellow;钨钍/黄色	10
IJHC0071-48	Tungsten Th WT10 Φ 4.8X175mm Yellow;钨钍/黄色	10
IJHC0077-05	Tungsten Th WT10 Φ 0.5X175mm Yellow;钨钍/黄色	10
IJHC0078-10	Tungsten Th WT40 Φ 1.0X175mm Orange;钨钍/橙色	10
IJHC0078-16	Tungsten Th WT40 Φ 1.6X175mm Orange;钨钍/橙色	10
IJHC0078-20	Tungsten Th WT40 Φ 2.0X175mm Orange;钨钍/橙色	10
IJHC0078-24	Tungsten Th WT40 Φ 2.4X175mm Orange;钨钍/橙色	10
IJHC0078-30	Tungsten Th WT40 Φ 3.0X175mm Orange;钨钍/橙色	10
IJHC0078-32	Tungsten Th WT40 Φ 3.2X175mm Orange;钨钍/橙色	10
IJHC0078-40	Tungsten Th WT40 Φ 4.0X175mm Orange;钨钍/橙色	10
IJHC0078-48	Tungsten Th WT40 Φ 4.8X175mm Orange;钨钍/橙色	10
IJHC0079-10	Tungsten La WL15 Φ 1.0X150mm Gold;镧钨/金色	10
IJHC0079-16	Tungsten La WL15 Φ 1.6X150mm Gold;镧钨/金色	10
IJHC0079-20	Tungsten La WL15 Φ 2.0X150mm Gold;镧钨/金色	10
IJHC0079-24	Tungsten La WL15 Φ 2.4X150mm Gold;镧钨/金色	10
IJHC0079-32	Tungsten La WL15 Φ 3.2X150mm Gold;镧钨/金色	10
IJHC0079-40	Tungsten La WL15 Φ 4.0X150mm Gold;镧钨/金色	10
IJHC0079-48	Tungsten La WL15 Φ 4.8X150mm Gold;镧钨/金色	10
IJHC0070-10	Tungsten La WL15 Φ 1.0X175mm Gold;镧钨/金色	10
IJHC0070-16	Tungsten La WL15 Φ 1.6X175mm Gold;镧钨/金色	10

TUNGSTEN ELECTRODES 钨棒



Code	Description	Pack
IJHC0070-20	Tungsten La WL15 Φ 2.0X175mm Gold; 钨钨/金色	10
IJHC0070-24	Tungsten La WL15 Φ 2.4X175mm Gold; 钨钨/金色	10
IJHC0070-32	Tungsten La WL15 Φ 3.2X175mm Gold; 钨钨/金色	10
IJHC0070-40	Tungsten La WL15 Φ 4.0X175mm Gold; 钨钨/金色	10
IJHC0070-48	Tungsten La WL15 Φ 4.8X175mm Gold; 钨钨/金色	10
IJHC0076-10	Tungsten La WL20 Φ 1.0X175mm Blue; 钨钨/蓝色	10
IJHC0076-16	Tungsten La WL20 Φ 1.6X175mm Blue; 钨钨/蓝色	10
IJHC0076-20	Tungsten La WL20 Φ 2.0X175mm Blue; 钨钨/蓝色	10
IJHC0076-24	Tungsten La WL20 Φ 2.4X175mm Blue; 钨钨/蓝色	10
IJHC0076-32	Tungsten La WL20 Φ 3.2X175mm Blue; 钨钨/蓝色	10
IJHC0076-40	Tungsten La WL20 Φ 4.0X175mm Blue; 钨钨/蓝色	10
IJHC0076-48	Tungsten La WL20 Φ 4.8X175mm Blue; 钨钨/蓝色	10
IJHC0076-64	Tungsten La WL20 Φ 6.4X175mm Blue; 钨钨/蓝色	10
IJHC0072-10	Tungsten La WL20 Φ 1.0X150mm Blue; 钨钨/蓝色	10
IJHC0072-16	Tungsten La WL20 Φ 1.6X150mm Blue; 钨钨/蓝色	10
IJHC0072-20	Tungsten La WL20 Φ 2.0X150mm Blue; 钨钨/蓝色	10
IJHC0072-24	Tungsten La WL20 Φ 2.4X150mm Blue; 钨钨/蓝色	10
IJHC0072-32	Tungsten La WL20 Φ 3.2X150mm Blue; 钨钨/蓝色	10
IJHC0072-40	Tungsten La WL20 Φ 4.0X150mm Blue; 钨钨/蓝色	10
IJHC0072-48	Tungsten La WL20 Φ 4.8X150mm Blue; 钨钨/蓝色	10
IJHC0072-64	Tungsten La WL20 Φ 6.4X150mm Blue; 钨钨/蓝色	10

Code	Description	Pack
IJHC0073-10	Tungsten La WL10 Φ 1.0X175mm Black; 钨钨/黑色	10
IJHC0073-16	Tungsten La WL10 Φ 1.6X175mm Black; 钨钨/黑色	10
IJHC0073-24	Tungsten La WL10 Φ 2.4X175mm Black; 钨钨/黑色	10
IJHC0073-32	Tungsten La WL10 Φ 3.2X175mm Black; 钨钨/黑色	10
IJHC0073-40	Tungsten La WL10 Φ 4.0X175mm Black; 钨钨/黑色	10
IJHC0073-48	Tungsten La WL10 Φ 4.8X175mm Black; 钨钨/黑色	10
IJHC0073-64	Tungsten La WL10 Φ 6.4X175mm Black; 钨钨/黑色	10
IJHC0073-80	Tungsten La WL10 Φ 8.0X175mm Black; 钨钨/黑色	10
IJHC0074-80	Tungsten La WL10 Φ 8.0X85mm Black; 钨钨/黑色	10
IJHC0075-16	Tungsten La WL10 Φ 1.6X150mm Black; 钨钨/黑色	10
IJHC0075-24	Tungsten La WL10 Φ 2.4X150mm Black; 钨钨/黑色	10
IJHC0075-32	Tungsten La WL10 Φ 3.2X150mm Black; 钨钨/黑色	10
IJHC0081-10	Tungsten WR2 Φ 1.0X175mm Emerald; 钨钨/翠绿色	10
IJHC0081-16	Tungsten WR2 Φ 1.6X175mm Emerald; 钨钨/翠绿色	10
IJHC0081-24	Tungsten WR2 Φ 2.4X175mm Emerald; 钨钨/翠绿色	10
IJHC0081-32	Tungsten WR2 Φ 3.2X175mm Emerald; 钨钨/翠绿色	10
IJHC0081-40	Tungsten WR2 Φ 4.0X175mm Emerald; 钨钨/翠绿色	10
IJHC0081-48	Tungsten WR2 Φ 4.8X175mm Emerald; 钨钨/翠绿色	10

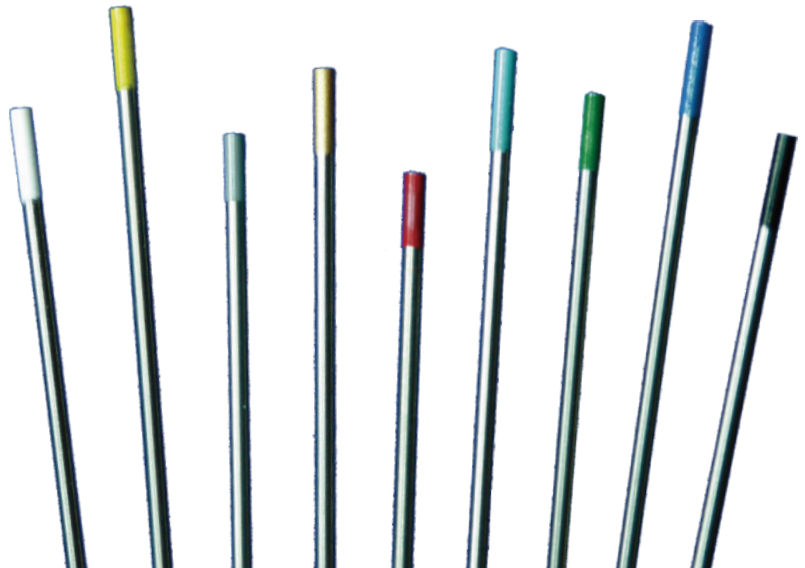

YOUR CHOICE

**PRODUCT
MANUAL**

**COMPANY INTRODUCTION
TIG TORCHES
SPARE PARTS**

**YOUR PROFESSIONAL
WELDING SUPPLIER**

TIG

